

# Dictionary of Moisture Protection and Resoration



**TENON**<sup>®</sup>

A TCC Materials<sup>®</sup> Brand

# TABLE OF CONTENTS

<b>I.</b>	<b>ACKNOWLEDGMENTS</b>	<b>iv</b>
<b>II.</b>	<b>WATERPROOFING, THERMAL AND MOISTURE PROTECTION</b>	<b>1-14</b>
<b>III.</b>	<b>SEALANTS</b>	<b>15-30</b>
<b>IV.</b>	<b>MASONRY - TERMINOLOGY AND TOOLS</b>	<b>31-74</b>
<b>V.</b>	<b>STONES - ORIGIN AND USE</b>	<b>75- 87</b>
<b>VI.</b>	<b>LANDMARK ELEMENTS, ILLUSTRATIONS, AND DESCRIPTIONS</b>	<b>88-142</b>

# I. ACKNOWLEDGMENTS

Harris, Cyril M. *Dictionary of Architecture & Construction*. Third edition. Edited by Cyril M. Harris, Professor Emeritus of Architecture, Columbia University. McGraw-Hill Publisher 2000.

Kubal Michael T. *Construction Waterproofing Handbook*. Edited by Larry Hager. McGraw-Hill Publisher 1999.

Schwartz, Max. *Basic Engineering*. 1993 Edition, with permission of Lawrence Jacobs. [Jacobs@costbook.com](mailto:Jacobs@costbook.com)

Voss and Henry Architectural Construction. By Walter C. Voss S.B. Head of Department of Architecture, Wentworth Institute, Boston, Massachusetts and Ralph Coolidge Henry S.M. Architect, Boston, Massachusetts. John Wiley & Sons Inc. Press 1925.

Brick Institute of America. *Bricklaying Brick and Block Masonry* with permission of the Brick Industry Association [www.gobrick.com](http://www.gobrick.com)

## II. WATERPROOFING THERMAL AND MOISTURE PROTECTION

### *MasterFormat – Division 07*

#### **Facts:**

- 1) 95% of construction litigation is the result of water intrusion.
- 2) 90% of all water intrusion problems occur within 1% of the structure's exterior surface area.
- 3) 95% of all water leaks are attributable to causes other than material or system failures.

While individual waterproofing materials and systems continue to improve, no one is improving the necessary, and often critical, detailing that is required to transition from one building component to the next. Furthermore, we seem to move further away from the superior results achieved by applying basic waterproofing principles, such as maximizing roof slopes, to achieve desired aesthetic values instead. There is no reason that aesthetics cannot be fully integrated with sound waterproofing guidelines. It is up to the industry to acknowledge these shortcomings and to resolve water intrusion problems at the job site rather than in the courtroom.

*How is the water penetrating into any structure?*

*The same way it has ever since we built structures!*

**3 conditions create water intrusion (WOW)**

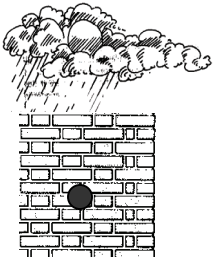

**1. Water.** Water is present at the outer face of the wall.

**2. Opening.** There is an opening through which the water can pass.



**3. Wind.** A force to drive the water through the opening.

*We cannot do anything about the water (rain) and the wind, but we sure can do something about the opening.*

**If there is a breach, water will intrude by using the following forces:**

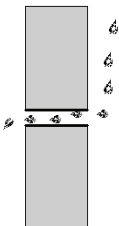

**1. Natural gravity.** Water washing down the face of a building directly into an opening.

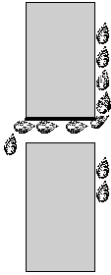

**2. Surface tension.** Water adheres to the surface of an opening and travels inward along it.

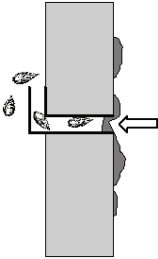

**3. Capillary action.** Water travels inward because its adhesion to the walls of an opening is stronger than the cohesive forces between the liquid molecules. This occurs in very porous substrates.

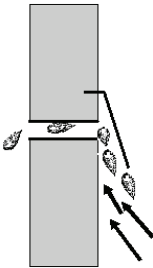

**4. Wind / air currents.** The wind currents can create sufficient air pressure to force the water upward and over the components.

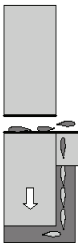

**5. Hydrostatic pressure.** Pressure applied to the building envelope materials by various heights of water at rest.

## ***Solving Water Intrusion Problems Restoration or Remedial Waterproofing***

**Now that we know how the water is penetrating a structure, how can we stop it?**

In restoration or remedial approaches to solving water intrusion, the following actions are vital:

1. Inspection of damage and leakage.  
(Visual inspection and testing).
2. Determination of cause.
3. Choice of systems for repair.
4. Substrate preparation.
5. Restoration work.
6. Waterproofing system application.

Prevention of water leaks has to include one of the three basic systems:

- 1. Barriers**
- 2. Drainage**
- 3. Diversions**

Understand that not all water penetration through the substrate results in leakage to interior spaces. Masonry surfaces absorb some water regularly, without creating interior leaks. The masonry is either large enough to absorb the penetrating water, or this water is collected and redirected back to the exterior by the use of dampproofing systems. This is also true when it comes to mortar joints.

# 1. Barrier Systems

Barrier systems are, as their name implies, effective and complete barriers to water infiltration. They completely repel water under all expected conditions, including gravity and hydrostatic pressure.

Such barriers include all types of impermeable materials above and below grade such as: membranes, glass, or metal that will completely repel the water.

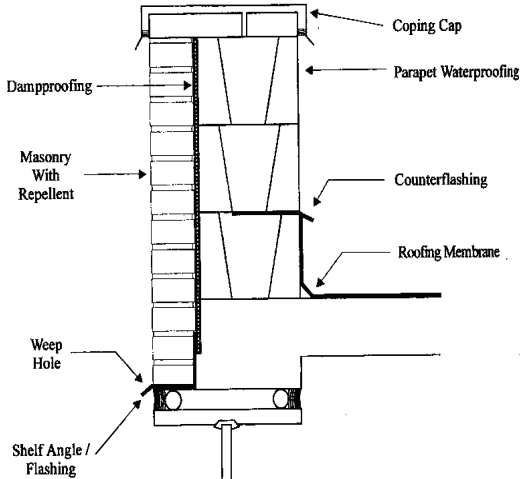

Barriers are the most important element to consider in the design phase of a waterproofing project.

## **Barrier Systems (continued)**

The barriers are as much systems as they are materials. The function of the barriers is to prevent any water penetration into the substrates.

They include metal, glass, and composite materials such as sheet and liquid membranes for vertical and horizontal applications.

The most popular system today is the elastomeric, which is a waterproofing material with the ability to return to its original shape and size after substrate movement during expansion or contraction.

Elastomeric is used mainly as a remedial system, because the original barrier, such as the building paper, is no longer performing, or the original design or application was not adequate.

Elastomeric works the same way as your skin; it allows the flesh (substrate) to breathe, but does not allow the water to penetrate.

In most cases, the original barrier is abandoned when the elastomeric coating is applied. It is an economically attractive option compared with the cost of removing the sacrificial materials and the building paper then reinstalling the barrier.

Elastomeric materials should not be considered as a technological breakthrough, but as an economical way to provide an alternate barrier. As the original barrier and diversion system are abandoned, the barrier is moved to the surface of the wall where transition joints are critical.

## Barrier Systems (continued)

**Water repellents** should **not** be considered as a typical barrier for waterproofing purposes.

They penetrate the substrates, filling the pores. After curing, they remain as a solid material or shield that provides water repellency. They are identified as: acrylics, silanes, siloxanes or stearates, depending on their composition.

Which water repellent to use is a complex process, which cannot be covered in this handbook. I suggest that you refer to the SWRI *“Clear Water Repellents for Above Grade Masonry and Horizontal Concrete Treatments Manual”*. This publication will give you a complete understanding of water repellents and a clear comparison of products.

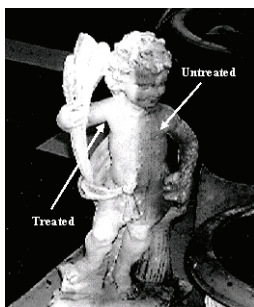

Here is an example of and option of water repellent use.

In my backyard, this Cherub was cleaned every spring and would turn green with mold every winter. In the summer of 2000, I cleaned it and applied a siloxane clear water repellent to the left side, leaving the right side untreated. In April 2002 the difference was obvious.

**Water repellents do not provide the impermeability requirement to be considered an acceptable barrier.**

## 2. Drainage

Drainage systems are components that might permit some water absorption and some infiltration through the substrate, but provide means to collect this water and divert it back out before it causes leakage.

They can also be prefabricated materials that facilitate the drainage of water away from the building envelope.

### DRAINAGE SYSTEMS

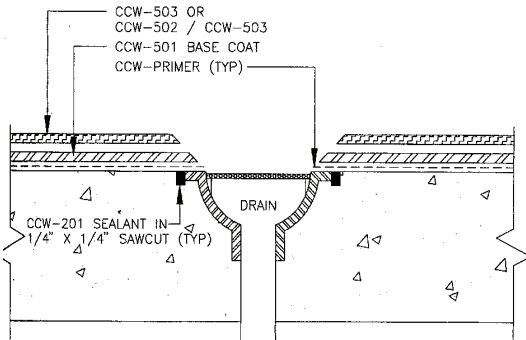
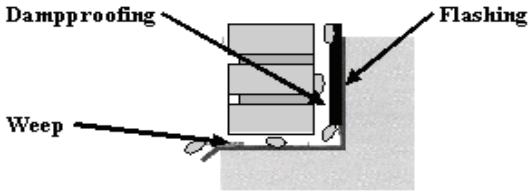

**Drainage system for decks**

### 3. Diversion

Diversion actually redirects the water being forced against the building and diverts it before it infiltrates the substrate.

Diversion techniques include sloping of roofs, decks and balconies; vertical drainage mats, gutters and downspouts, flashings, windscreens, French drains, etc.

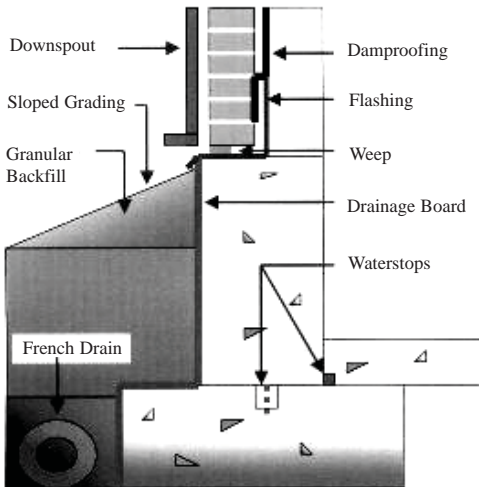

#### SYSTEM INCLUDING DIVERSION

Building facades usually contain combinations of these three systems; each preventing water infiltration at their locations.

**However, if they are not properly transitioned into other components, leakage will occur.**

## *Solving water intrusion problems*

### **1. Natural gravity**

To avoid any water penetration it is necessary to have:

- a) The proper barrier, without any breach so that the rain cannot penetrate at all.
- b) The proper sloping. (Minimum  $\frac{1}{4}$ " per foot.) A good example is the teepee; built of materials that are hardly waterproofed. The interior will remain dry because the design sheds the water off immediately. However, use the same material in a horizontal or minimally sloped area and water will penetrate the same material.



## 2. Surface tension

To solve this problem it is necessary to:

1. Install and maintain *drip edges* and *flashings* to break the momentum of the water and prevent it from clinging to the underside of the horizontal surfaces and continuing into the building.
2. Provide and maintain sound mortar joints.

The most common mistakes in restoration are:

- Not repointing joints where necessary.
- Filling or omitting new drip edges when repairing or installing components.
- Not replacing non-performing flashings or not installing new ones where required.

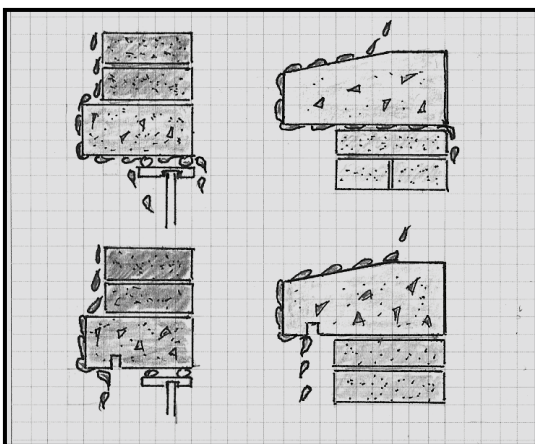

Above: window header and sill without drip edge

Below: window header and sill with drip edge

### 3. Wind / air currents

When wind is present in a rainstorm, envelopes or cladding become increasingly subject to water infiltration.

Besides the water being directly driven into the cladding by the wind currents, sufficient air pressure can cause hydrostatic pressure on the façade and force the water upward and over the components.

Again, proper flashings should be designed and used to prevent this phenomenon from causing water penetration into the structure.

**The cleat will  
at the bottom  
prevents uplift  
of the system.**

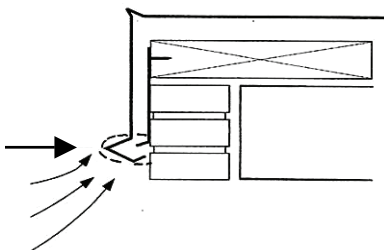

**Flashing used to prevent water under pressure  
from entering.**

The height of the flashing is determined by the expected maximum speed and wind pressure.

All too often the height is not adequate because of aesthetic conflicts.

This detail is too important to take a back seat to design consideration.

## Capillary action:

Capillary action happens in situations where water is absorbed by wicking action.

This will happen mostly with masonry and concrete at or below grade levels.

These materials have a natural high degree of minute void space within their composition. These minute voids actually create a capillary suction force that draws water into the substrate when standing water is present. This is similar to the action of a sponge laid in water and absorbing the water.

Ironically, materials that have large voids or are very porous are not susceptible to capillary action in buildings. For example, sand is often used as a fill below concrete slabs to prevent the concrete from drawing water from the soil through capillary action.

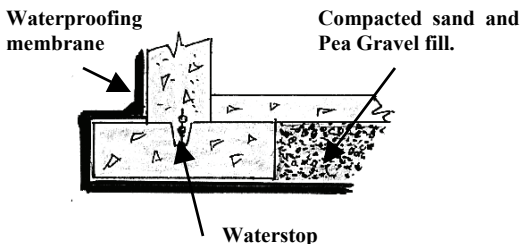

**The best way to prevent capillary action is to install a good barrier. In this case the barrier can be a waterproofing membrane, waterstops and compacted sand and pea gravel fills.**

## Hydrostatic pressure:

Hydrostatic pressure is the pressure equivalent to that centered on a surface by a column of water of a given height. The height of water due to its weight creates pressure on the lower areas (referred to as *hydrostatic pressure*).

This pressure can be significant where the water table is near the surface or rises near the surface during heavy rainfalls.

Water under this pressure will seek out any breaches, especially areas of weakness ( i.e. the terminations and transitions between components).

These below grade components need a much better waterproofing system than the same components above grade.

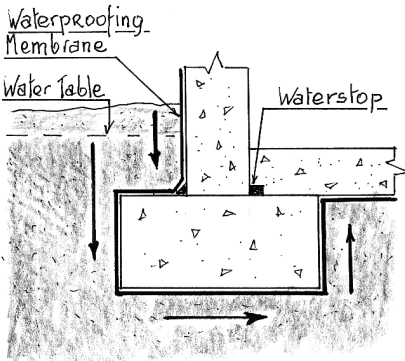

**Hydrostatic Control System**

**END CHAPTER II**

### III. SEALANTS

**The best barrier, drainage and diversion systems will not work if the transition joints are not properly installed. The majority of the failures are due to faulty joint installation or use of the wrong sealant.**

#### COMMON SEALANT COMPOSITIONS AND USES

##### **Acrylics:**

Factory mixed materials polymerized from acrylic acids.

These are used frequently in remedial preparation work before the application of acrylic-based waterproofing coatings. They are available in brushable or trowel grades for use in preparing small cracks in substrates. Acrylic base sealants do not require primers and need minimal surface preparation.

**These have low movement capability. Do not use acrylic sealants in high-movement, vehicular and/or pedestrian joints or continuously submerged joints.**

##### **Butyls:**

Sealants produced by polymerization of isobutylene and isoprene rubbers.

These are the oldest technology in sealants. New technological advancements in better performing sealants have now limited their use to glazing windows or curtain walls with minimum movement.

They have good adhesion and weathering capabilities. Butyls are easy to install, they are

available in one-component packaging, do not require priming, and are paintable.

**Do not use butyls for high-movement, water-immersed or traffic joints.**

**Latex:**

Acrylic emulsions or polyvinyl acetate derivatives.

These are typically used for interior applications when a fast cure time is desired for painting. They can be coated sometimes in less than one hour. These materials have very low movement capability, high shrinkage rates and only fair adhesion properties.

**Latex materials should not be used for any exterior application.**

**Polysulfides:**

Produced from synthetic polymers of polysulfide rubbers.

They are manufactured in one and two-component packaging with a wide range of colors.

Polysulfides are acceptable for a wide range of applications. They require primers on all substrates and the required primers vary from substrate to substrate.

Polysulfides have been replaced by urethanes and silicones, which have better recovery ability and joint movement capability.

**Polysulfides should not be used for joints that have bituminous residue or contamination, unless such residue can be completely removed. (This is very difficult to achieve.) They should not be used for joints of substrates containing asphalt or oil-based products.**

### **Polyurethanes:**

Various polymers produced by chemical reactions formed by mixing di-isocyanate with hydroxyl, used to make flexible and rigid foams, elastomers and resins.

Many urethanes are moisture-cured materials. Other two-component urethanes are chemically curing mixtures. Their compatibility with most substrates and waterproofing capability has made them a commonly specified sealant for most waterproofing projects. Their formulations range from one-component and two-component self-leveling grade for horizontal joints, to one-component and two-component non-sagging grade for vertical expansion joints. Some urethanes are manufactured to meet the USDA requirements for food processing plants.

Urethanes have excellent recovery capabilities, 90% or more, and have very good weathering characteristics.

As urethanes are extremely moisture-sensitive during curing, closed-cell backer rod should be used, except for the one-component materials where open-cell is acceptable.

In most applications, priming is not required, however, manufacturers differ in their specifications especially for very smooth substrate surfaces. So it is important to follow the manufacturer's specification.

**Do not use urethanes in joints containing polysulfide or asphalt base sealants or residue unless they can be completely removed. They should not be used in glazing applications or high performance glass, plastics or acrylics.**

Most sealants, except latex, exceed the movement capabilities of paint, so they should

not be painted **except when they can be coated with elastomerics of comparable elongation.**

**Silicones:**

Derivatives of silicon produced by combining silicon, oxygen, and organic materials.

Silicones have extremely high thermal stability and are used as abrasives, lubricants, paints, coatings and synthetic rubbers.

Silicones are available in a wide range of compositions that are extremely effective in high-movement joints. They have excellent recovery capabilities, usually up to 100%.

Silicones have very little shrinkage, 3%, and a tack-free time of only 1 – 3 hours. High-tensile strength silicones with lower movement are typically used in glazing (wet seal) applications.

Most silicones come in one-component packaging. They have excellent adhesion to almost all building products **if such substrates are properly prepared.** They come in a variety of standard or custom colors, as they cannot be painted over, except for siliconized elastomerics. Silicones contaminate all surfaces they encounter, making it virtually impossible to seal over with any other types of sealants. Only abrasive methods can remove silicone residue or primers.

**Do not use silicones below grade, submerged or for horizontal applications subject to vehicular traffic.** The uncured silicone can stain or change the color of the substrates.

**Pre-formed silicone and polyurethane tapes:**

These are relatively new technologies in urethane and silicone.

They are pre-cured elastic strips with greater than 800% elongation and superior weathering characteristics. These strips or tapes are installed by covering the joint and using the silicone or urethane sealants for bonding on either side. They are used for rehabilitation of joints that have failed and replacement to cutting out and re-caulking.

**Do not use when there is vehicular traffic.**

**Precompressed foam sealants:**

These are open-cell polyurethane foam, impregnated with neoprene rubber sealant. They are manufactured to the required dimensions but are expensive.

**Do not use for submersion or below-grade applications. Possible staining of substrate may occur.**

*Sealants are not only the most important and widely used waterproofing materials, but also the most incorrectly used. They are minor cost items, but contribute a major function in a building's life cycle.*

We ask a lot from our sealants, but we do not treat them very well!

They are required to provide watertight transitions between different materials, to secure waterproofed joints between similar materials (e.g. sheet membrane joints) and provide watertight expansion capability between moving building components.

How many times have you heard “**caulking is caulking**”? This is totally false.

## CHOOSE THE RIGHT SEALANT

Too often, the contractor or installer will depend on past experience with a specific sealant regardless of the requirements. **“It always worked before – I never had any problem with this material”**. Well, this is a sure way to get in trouble! Most contractors and applicators do not have the technical knowledge to make the decision on the proper products to be installed in order to meet all requirements. However, they do know what is expected from a sealant under specific conditions.

The input from the manufacturers is critical. After all, they are the ones you are going to call if your sealant fails. When you call them, be precise and truthful. Manufacturers cannot help you unless you give them the proper information:

1. Joint design and size.
2. Substrate (concrete, stone, metal, etc.)
3. Condition of the substrate.
4. Geographic location and weather conditions.
5. Expected performance from the sealant.
6. Your experience doing these types of projects.
7. Are they willing to warranty their sealants?
8. Then you can ask the price.

Generally, the contractor does not get the credit for the success of a sealant, but will get the blame if it fails.

## GENERIC SEALANT MATERIALS COMMON USES

SUBSTRATE	ACRYLIC	BUTYL	LATEX	POLY-SULFIDE	POLY-URETHANE	SILICONE
Metal frames - interior						
Metal frames - exterior						
Precast Joints						
Glazing and bed joints						
Interior Work						
Stucco Crack Repairs						
Horizontal joints						
Wood joints						
Metal curtain walls						
Stone & masonry joints						
Bath fixtures						
High movement joints						
Parking deck joints						
Marble						
Granite						
Limestone						

Silicones for parking decks are not widely used, but are now available.

## INSTALLATION

**Of all factors affecting the performance of a sealant, installation is the most critical.**

Successful installation depends on several steps including:

1. Joint preparation.
2. Priming when required.
3. Installation of backer rod or backing tape.
4. Mixing, applying, and tooling of sealant.

### **Joint preparation**

- A. Problems: Joints are not cleaned or are contaminated, incorrect solvents are used and substrates are not dry.
- B. Solution: Use two rags: one to wet the joint with solvent, the other to wipe the joint.

Using one rag will only smear the contaminants. Remove all mortars, aggregates and foreign matter as the sealant will only pull them away from the substrates when the joint moves.

Other contaminants such as sealers, oils, waxes, and curing agents will require removal using mechanical methods such as grinding. Please remember, after a mechanical cleaning, the joints must be recleaned to remove dust and residue left behind by the mechanical cleaning.

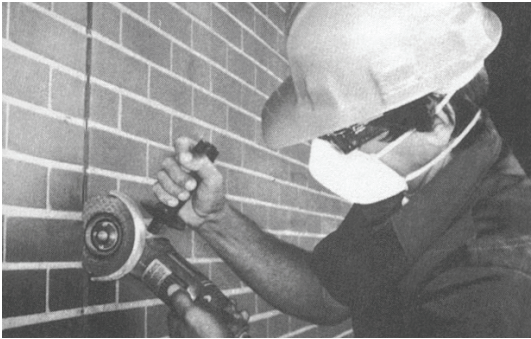

**Preparation of substrate by grinding.**  
(Courtesy of SWRI)

### **Priming**

- A. Problems: Too much primer, primer overcured, application of sealants over wet primer.
- B. Solutions: Use proper primer. Do not overapply primer. Discard old or contaminated primers. Follow the manufacturer's recommendations.

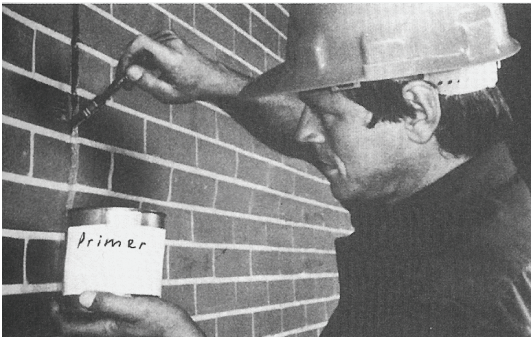

**Proper priming of joint. (SWRI)**

## **Backer rod or backing tape installation**

- A. Problems: Cohesive failure due to incorrect backing materials. Lack of depth consistency.
- B. Solutions: Prevent three-sided adhesion. Use adaptable packing tools to avoid inconsistent depth of the rod.



### **Proper installation of backing materials with packer tool. (SWRI)**

#### **Mixing, applying, and tooling**

Problems: Improperly mixed sealants will never cure and so will never provide the physical properties required. Improper selection of gun nozzle. Improper installation. Incorrect tooling.

Solutions: Use proper mixing paddles and adequate amount of time. Never use materials beyond their shelf life. Use proper tools and nozzles, proper tooling to

eliminate voids or bubbles and ensure that the sealants press completely against the sides of joints. Joints should be tooled to a concave finish. Soaps or solvents should never be used in tooling. This will cause improper curing, adhesion failure, or color change.

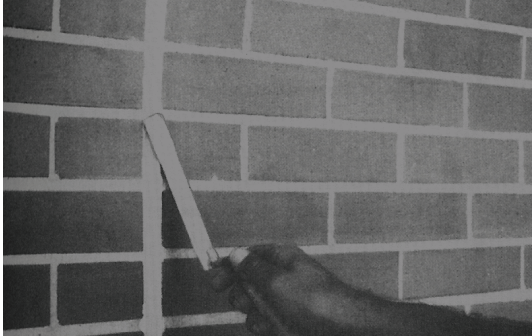

**Proper tooling of joint. (SWRI)**

Proper mixing, application, and tooling includes:

- Recommended temperature ranges, typically 50 to 80 degrees F.
- Mixing only complete packages of materials.
- Mixing for proper amount of time.
- Keeping air out of sealant during mixing.
- Using properly sized nozzles and slopes to fill joints.
- Tooling by compression, for adequate adhesion.
- Avoiding use of soaps or solvents in finishing joints.

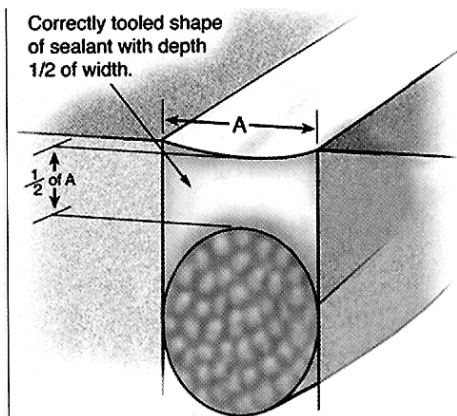

## The hourglass system

Most manufacturers recommend this system. This hourglass detail allows materials to move properly and enhances the physical properties of the sealant. By maintaining this typical detail, you will avoid cohesive and adhesive failures.

## Cohesive failure

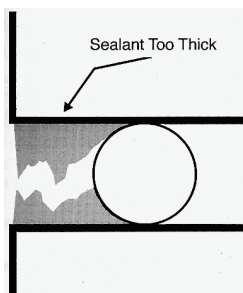

Sealant material applied too thickly will result in cohesive failure.

When the sealant is so thick that it cannot elongate when the substrate is experiencing expansion, it literally rips itself apart, usually in the middle of the joint, when the substrate separates.

## Adhesive failure

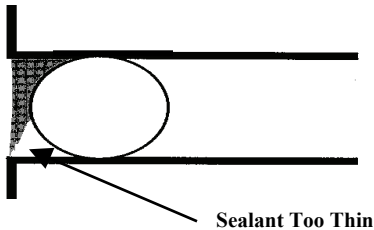

Sealant material applied too thinly results in adhesive failure.

When there is insufficient sealant material adjacent to the side of the substrate to permit expansion, the sealant is ripped off the side of the joint (insufficient bonding).

## Three-sided adhesion

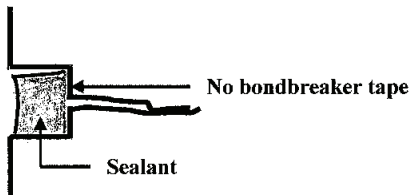

When the substrate moves, one side will lose its adhesion. This will cause an adhesive failure but could also create a cohesive failure.

When performing a pull test on sealant joints, the report will identify the **cohesion failure or adhesion failure**. The cohesion failure means that the sealant has good adhesion and will break at the center before it will give up the adhesion.

## SEALANT APPLICATIONS

### Correct

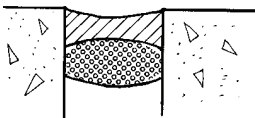

Backer rod properly inserted. Mortar cut back to provide uniform and proper joint depth.



Bondbreaker tape eliminates adhesion of the sealant to the back of the joint.

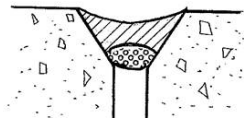

The bondbreaker increased width at the base increasing the sealant's ability to compensate for greater movement.

### Incorrect

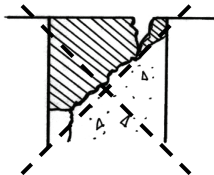

Irregular depth creates unequal stress on sealant = cohesive and adhesive failures.

Remove the mortar, provide an evenly deep joint and install a backer rod.

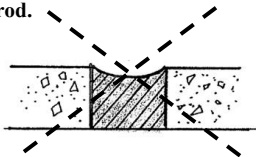

No bondbreaker, sealant adheres to back of the joint, thus creating a cohesive tear when movement occurs

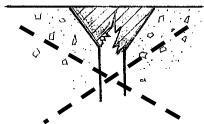

Sealant can only compensate for movement at the narrowest point. If the movement exceeds the sealant's limitation, a cohesive tear will develop.

### Correct

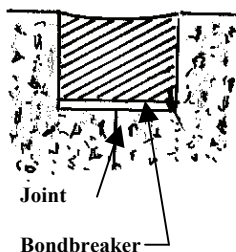

← MOVEMENT →

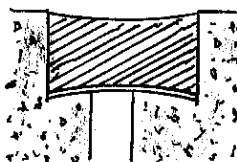

Proper joint treatment with bondbreaker tape installed. The fact that the sealant rides on the top of the bondbreaker (no three-sided adhesion) allows the sealant to work properly without a cohesive tear.

### Incorrect

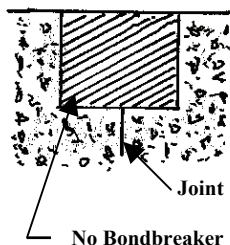

← MOVEMENT →

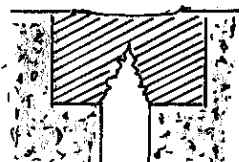

This is an exaggerated illustration of the same joint where the sealant has been installed over the masonry without a bondbreaker. The result is a cohesive tear when the joint moves.

There are hundreds of sealant details but all of them should address the same principle: **avoid three-sided adhesion.**

Three-sided adhesion is the cause of the majority of transition joint failures in rehabilitation projects.

## MORE JOINT DETAILS

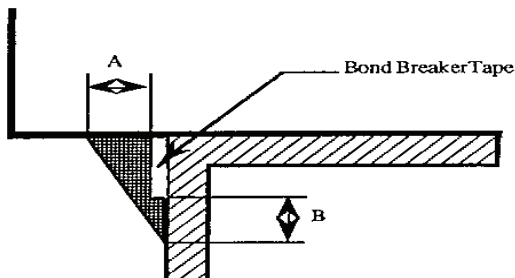

**Metal-frame joint Distance A should equal distance B for equal expansion and movement.**

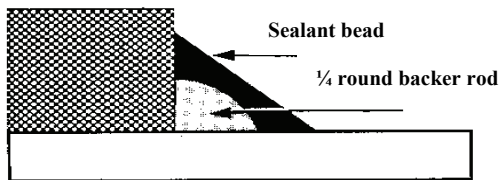

I cannot emphasize enough the importance of transition joints. You can have the best envelope system, but if the transition joints fail, the entire system will fail.

I often find failures in residential wood frame structures where the building paper under the stucco has been compromised. The building paper is replaced with an elastomeric coating on the stucco, but the transition joints are ignored. The elastomeric system is blamed for the water intrusion, but in fact the joints are the culprits. **Proper attention to joints is essential for a successful waterproofing scope.**

**END CHAPTER III**

## IV. MASONRY – TERMINOLOGY AND TOOLS

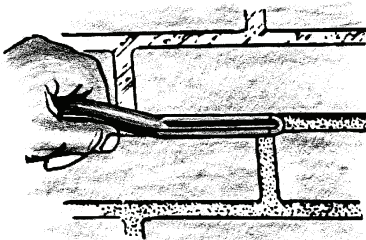
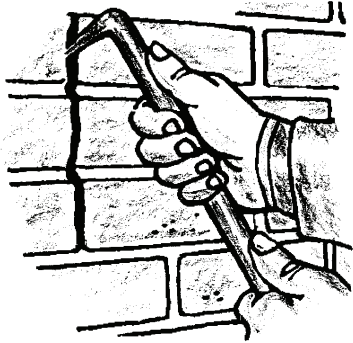
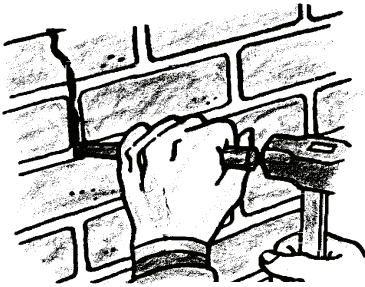

Reprints from:  
Brick Institute of America – Bricklaying

## MASONRY WORK

Both knowledge and technique are required to repair and restore masonry work. No matter how long you have been working in the masonry field, unfamiliar problems and situations continue to come up. The understanding of how the original or previous installations took place and the knowledge of the correct trade terminology are essential. A lot of research and testing is often required before starting a masonry restoration project.

It is a challenging trade, as we are required to preserve and/or restore masonry, which most of the time does not meet existing codes and standards. Masonry walls have a high compressive strength, but they are weak in flexure. While restoring such walls, you will often be faced with providing new control joints and installing new reinforcing steel to help the building meet the current codes, but you still have to preserve the original appearance.

The following illustrations and descriptions will offer you easy references and help you solve most problems.

Correct trade terminology is emphasized to help you communicate and perform the scope of restoration.

Please refer to local building codes as they vary from state to state, especially where seismic requirements are different.

**Absorption rate =**

Weight of water absorbed by masonry unit (usually brick) in one minute.

**Accelerator =**

A substance which (when added to concrete, mortar or grout), increases the rate of hydration, (shortening the time of set), or increasing the rate of hardening or strength.

**Adhesion =**

The ability of mortar to stick to masonry units.

**Admixture =**

Material added to mortar, concrete, or grout to change the character of the mortar as a water repellent, coloring agent, retarder, or accelerator.

**Adobe brick =**

Unit made of clay with asphaltic materials sometimes added. Unit is sun-hardened.

**Aggregate =**

Material, such as sand or gravel, added to mortar.

**Ashlar =**

A square or rectangular cut stone.

**Arris =**

Sharp edge made where two surfaces or sides meet.

**Bat =**

A broken brick. Often half brick.

### **Battered wall =**

A wall with a sloping back to withstand the hydrostatic pressure that builds up behind the wall.

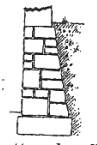

### **Bearing wall =**

A wall capable of supporting an imposed load. Also called a structural wall or loadbearing wall.

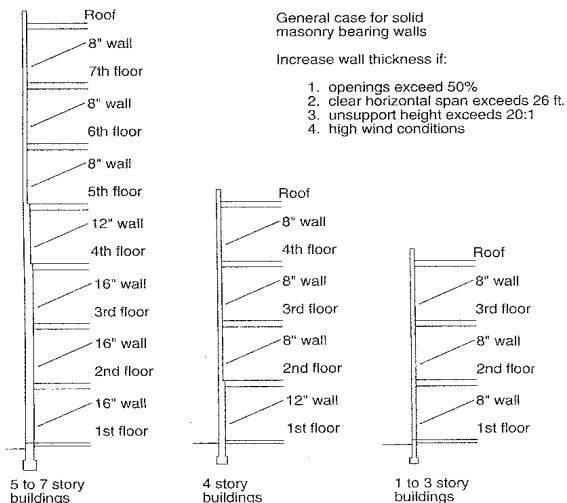

### **Bed =**

The bottom side of brick or block as it has been laid.

### **Bed joint =**

A horizontal layer of mortar on which masonry units are laid.

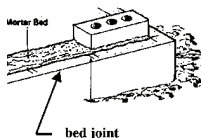

**Belt course =**

A band of masonry extending horizontally across the façade or the perimeter of a building. Usually projects beyond the face of the building. Also called a **string course** or a **band course** or a **sill course** when set at the windowsill level.

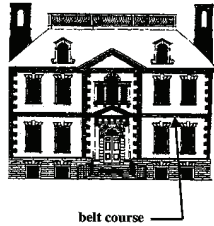

**Bond patterns =**

An arrangement of masonry units (header and stretchers) laid in a pattern that provides a brick wall with strength, stability, and in some cases, beauty, depending on the pattern.



**RUNNING**

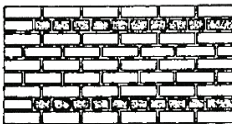

**COMMON**



**STACK**



**FLEMISH**

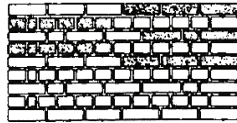

**ENGLISH**

## Bond patterns (continued)

### English cross bond or St. Andrew's cross bond =

Similar to English bond, but the stretchers, in alternating courses, have their joints displaced by half the length of a stretcher.

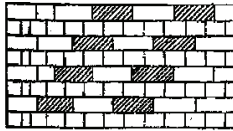

### Bond header =

In masonry, a bondstone that extends the full thickness of the wall (also called a throughstone).

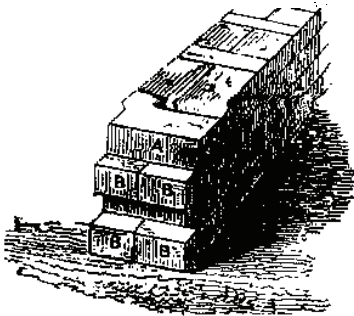
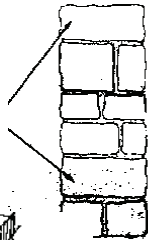

### In-and-out bond =

In masonry, a bond formed by headers and stretchers alternating vertically, esp. when formed at a corner, as by quoins.

### Other bonds include:

Basketweave, Chinese, Dutch, Flying, Garden, Monk, Raking stretcher, Rat-tap, Rowlock, Silver-lock, Sussex and Yorkshire bonds.

**Brick =**

Rectangular masonry unit, with or without cores (holes) made by firing shaped clay in a kiln at an elevated temperature to harden it, so as to give it mechanical strength and to provide it with resistance to moisture.

After coming out of the kiln, the brick is said to be *burnt*, *hard-burnt*, *kiln-burnt*, *fired*, or *hard-fired*.

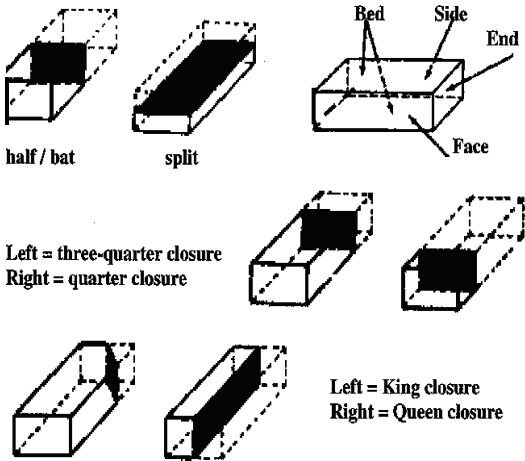

Various types of bricks are available: *acid-resistant*, *adobe*, *angle*, *arch*, *building*, *clinker*, *common*, *dry press*, *economy*, *engineered*, *facing*, *fire*, *floor*, *gaged*, *jumbo*, *modular*, *Norman*, *paving*, *Roman*, *salmon*, *SCR*, *sewer*, *soft-mud*, and *stiff-mud*.

**Brickwork =**  
Masonry of brick and mortar.

Bricklaying involves knowledge and experience of the basic technique.

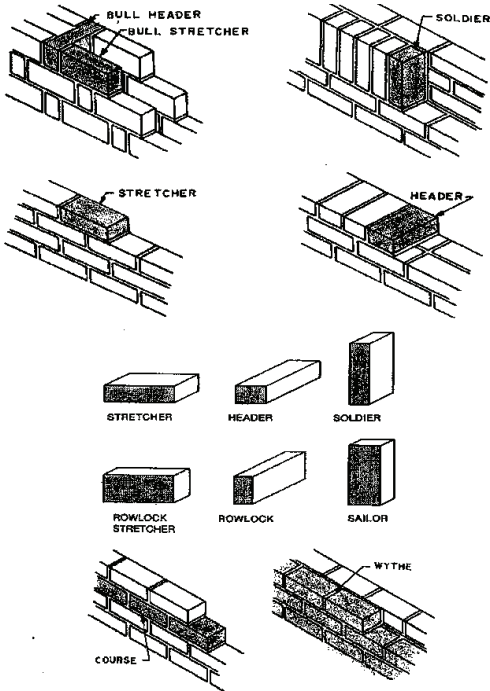

Good brickwork requires good workmanship, good tools, the proper materials and careful planning.

**Broken rangework =**

Stone masonry laid in horizontal courses of different heights, any one course of which may be broken (at intervals) into two or more courses.

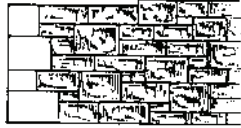

**Burning the joint =**

Mortar joint that is tooled after the mortar has partially set and is hard, leaving dark streaks.

**Cell =**

Void in masonry unit with a cross-sectional area greater than 1 ½ square inch.

**Cement (portland cement) =**

A mixture of materials (without aggregate) which, when in a plastic state, possesses adhesive and cohesive properties that harden in place. The term is frequently misused, e.g. “cement” block for concrete block. **Portland cement** = A calcined combination of limestone and clay, combined with an **aggregate** that reacts chemically when water is added.

**Centering =**

A temporary structure upon which the materials of a vault or arch are supported in position until the work becomes self-supporting.

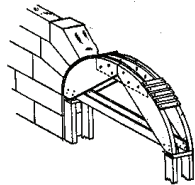

**Clinker brick =**

A very hard-burned brick whose shape is distorted or bloated due to nearly complete vitrification.

**Clip =**

Cut brick piece or section.

**Closer =**

The last brick or block laid in the course. Also (*closure*).

**CMU =**

Concrete Masonry Unit.

**Composite wall =**

Masonry wall with wythes of different materials, such as brick and block.

**Compression =**

Downward crushing load on a wall or beam, as on the top of a lintel.

**Control joint =**

Vertical joint made in the wall to allow for shrinkage and prevent cracking.

**Coping =**

Masonry cap on top of a wall or pier. Very important as a water barrier.

**Corbelling =**

A masonry technique of widening or projecting out a masonry wall (or part of a wall) to form a decorative feature, a support shelf or a ledge for a building element. Also used to widen a support wall. As a general rule, the masonry unit should not extend out more than one-third the width or one-half the height. The top course must be a full header course.

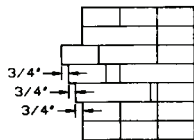

Details showing projections

**Crowding the line =**

Masonry laid so they touch the guideline; *an unacceptable practice*. To avoid this, the unit should be approximately 1/16" from the line.



**Crown =**

High point or apex of a curving arch.

**Cull =**

Reject. Masonry unit that does not meet standards.

**Curtain wall =**

An exterior wall that is non-load-bearing, having no structural function, but protects from water intrusion.

**Dampproofing =**

1. A treatment of concrete or mortar to retard the passage or absorption of water, or water vapor, either by applying a coating to exposed surfaces or by using a suitable admixture. 2. A damp course e.g. a layer of impervious material to prevent moisture intrusion.

**Dripstone =**

A projecting brick or molding to allow the water to run-off away from the wall, or a unit with a slot cut on the underside of the projection to stop the momentum of the water or surface tension.

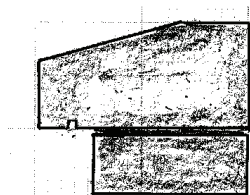

**Dry joint =**

Joint without mortar.

**Dwarf wall =**

A wall or partition which does not extend to the ceiling.

**EBM =**

Engineered Brick Masonry.

**Efflorescence =**

Powder or stain that forms on mortar, concrete, bricks or stone; usually caused by moisture leaching

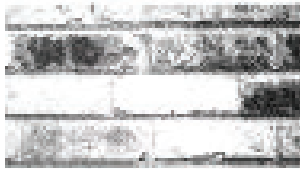

out salts from the material in the masonry. The remedy is simple: stop the moisture intrusions and allow the migration of the salts to take place; then remove the efflorescence by dry brushing or scraping. Acid washing the efflorescence will only dilute the salts, forcing them back into the substrate, only to migrate back later on.

**Expansion joint =**

A joint or gap between adjacent parts of a building structure or different materials that have different thermal expansion rates. (*see control joint for material movement due to a different cause*).

**Extrados =**

The outer curve on a masonry arch; as opposed to intrados.



**Facing =**

Part of an exterior masonry wall; finished surface.

**Fair raking cutting =**

Cutting exposed brickwork or facing at an angle to the horizontal, as the brickwork along a gable.

**Fat mortar =**

Mortar that is sticky and adheres to the trowel; contains a high percentage of cementitious materials. Opposite of *lean mortar*.

**Fire brick =**

Brick made of fire-resistant clay; used to line the firebox area of a fireplace.

**Fireplace =**

An opening at the base of a chimney, an open recess in a wall, in which a fire can be built.

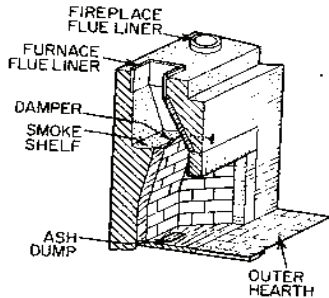
**Fire stone =**

Any stone, such as sandstone, that is fire resistant and suitable for use in fireplaces.

**Fire wall=**

A wall designed to resist the spread of fire from one part of a building to another. Walls are rated by the length of time they can resist fire.

**Flagstone =**

Terrace and outdoor paving, thin or split from rock that cleaves readily; produced by sawing.

**Flashing =**

A thin impervious material placed in construction, e.g. in mortar joints and through air spaces in masonry, to prevent water penetration or water drainage. Proper use and installation of flashings are crucial for waterproofing.

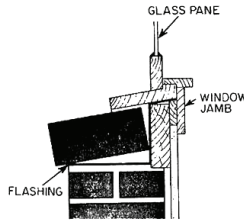
**Flash set =**

Very rapid set or hardening of mortar.

**Flue =**

An incombustible, heat-resistant enclosed passage that carries off smoke from a fireplace.

**Footing =**

Support for wall, column, or pier.

**Forehand =**

Laying brick by facing wall from outside and moving forward while laying brick. (See overhand).

**Frog =**

Small depression or indentation in the bed of a brick. Also part of the trowel.

**Frost line =**

Depth at which the earth freezes at a specific location.

**Frosted work =**

A type of masonry (ornamental, rusticated) work, having the appearance of frost on plants.

**Furring =**

Wood or metal strips fastened to the inside of a masonry wall as a base for interior finishes.

**Furrowing =**

Small indentation cut into the mortar bed by trowel; preparation of the mortar bed for the brick.

**Gauged arch =**

Arch shaped so that the joints radiate from a common center.



**Green =** Fresh mortar, mortar that has not set.

**Ground =**

A nailing strip placed in masonry walls as a means of attaching trim or furring.

**Ground course =**

The horizontal base course of masonry on the ground.

**Grout =**

Mortar of pouring consistency to fill voids in building units or between masonry walls. Made of Portland cement, lime, fine aggregates, and water. *See high-lift, low-lift grouting.*

**G.S.U.** =  
Glazed Structural Unit.

**Gunite** =  
A proprietary name for **shotcrete**.

**Hairline cracks** =  
Very fine cracks, in a random pattern which usually do not completely penetrate an exposed layer of concrete. Also called *shrinkage cracks* (when caused by shrinkage).

**Hairline joint** =  
A joint not more than 1/64 in. (0.38 mm) wide.

**Hair mortar** =  
A mortar containing cow's hair, lime and sand.

**Half bat, half brick, snap header** =  
A brick cut to half its length.

**Hard to the line** =  
Masonry unit set too close to the guide line.

**Harsh mortar** =  
Mortar that is difficult to spread.

**Hawk** =  
A small mortar board.

**Header** =  
A masonry unit laid flat on its bed surface with end facing out; also used to tie two wythes together.



**Headway** =  
Clear space under an arch.

**High-lift grouting =**

Grouting of hollow wall after it is built fairly high; grout is poured in lifts of around four feet.

**Hod =**

V-shaped, long-handled carrier for mortar.

**Hog =**

Improper laying, where one end of the wall has more courses than the other end, although both ends are the same height. Caused by different masons working on wall ends.

**Hollow brick =**

A masonry unit whose net cross-sectional area in any plane parallel to the bearing surface is less than 75% of its gross cross-sectional plane area.

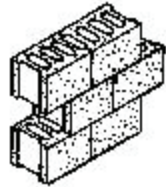

**Hydrated lime =**

Quicklime treated with water; used in masonry mortar. Also called *slaked lime*.

**Initial set =**

Beginning of mortar set.

**Intrados =**

Bottom course of an arch; opposed to extrados.

**IRA =**

Initial Rate of Absorption. Weight of water absorbed by a brick calculated in grams per 30 square inches of contact surface when brick is partially submerged in water for one minute.

**Joint =**

Edge or surface where two masonry units are laid together; the mortar-filled space between two masonry units.

**Jointing =**

Finishing of masonry joints. A metal jointer is used to smooth down and remove mortar. Also called *tooling*.

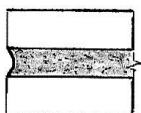

**concave**



**V-joint**

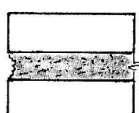

**grapevine**



**weathered**

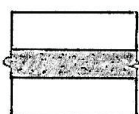

**beaded**

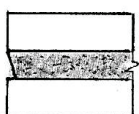

**struck**

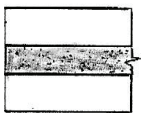

**flush**

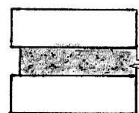

**raked**

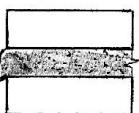

**extruded**

**Keystone =** The center brick or stone in an arch.

**Kiln =** Oven for firing brick or tile.

**King closure =**

Closure made using a brick with one corner cut off diagonally to give one two-inch end and one full-width end.

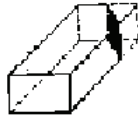
**Laitance =**

A layer of weak material containing cement and fines from aggregates, which is brought to the surface of overwet concrete by the bleeding of water to the top.

**Lap =**

Distance one masonry unit extends over another.

**Lateral thrust =**

Pressure from the side/horizontal load, for example, on the outside of the base of a round arch.

**Lead =**

Built-up masonry corner used as a guide in laying a wall.

**Lean concrete - lean mortar =**

Concrete or mortar of low cement content and thin consistency. Opposite of fat concrete or mortar.

**Lift =**

Height of grout, mortar or concrete placed at one time from one pour or application.

**Lime =**

Quicklime made by burning off calcium dioxide from limestone.

**Lime putty =**

Quicklime with water added to make a paste. Because of its caustic nature it must be thoroughly *slaked* before use.

**Lintel =**

Horizontal structural unit (beam) over an opening; support member over a door or window opening.

**Load =**

Weight on a structural unit or element.

**Low-lift grouting =**

Grouting of wall as it is built; grout is poured in lifts (height of six to eight inches). Opposite of *high-lift*.

**Mantel =**

A projection or facing around a fireplace opening often decorative. Stone or brick may be used. Same as *mantelshelf*.

**Manufactured stone =**

Artificial stone made from textured and colored concrete to simulate natural stone; used in veneer work.

**Mason =**

skilled specialist and journeyman who works with and lays brick, concrete blocks, and stone. Specialties are identified as brickmason, blockmason and stonemason.

**Masonry =**

Art and craft of laying masonry units of brick, concrete block, glass block, structural tile, and stone. Also construction of units of such materials as clay, shale, concrete, glass, gypsum, or stone, set in mortar. The following are different types of masonry: 1. Hollow masonry-units in which the voids exceed 25% of the cross-sectional area; 2. Solid masonry-units in which the voids do not exceed 25% of the cross-sectional area at any plane parallel to the bearing surface; and 3. Modular masonry-units manufactured to a nominal four-inch module size or a multiple of four inches.

**Mortar =**

Plastic mixture of cementitious materials, sand (aggregate) and water; used as a bed and for cementing masonry units in place. Also called *mud*.

**Mortar types:****Type S =**

1 part Portland Cement  
1/2 part Hydrated Lime  
4 1/2 parts sand

or

1 part Type II masonry cement  
4 1/2 parts sand

**Type M =**

1 part Portland Cement  
1/4 part Hydrated Lime  
3 parts of sand

or

1 part Type II Cement  
6 parts sand

## Mortar types: (continued)

**Type N =**            1 part Portland Cement  
                          1 part Hydrated Lime  
                          6 parts sand  
                          or  
                          1 part Type II masonry cement  
                          3 parts sand

**Type O =**            1 part Portland Cement  
                          2 parts Hydrated Lime  
                          9 parts sand  
                          or  
                          1 part Type I or II Cement  
                          3 parts sand

Masonry cement 94 pounds per cubic foot  
Portland cement 94 pounds per cubic foot  
Hydrated lime 40 pounds per cubic foot  
Sand 85 pounds per cubic foot

### **Type N mortar =**

1 part cement	= 1 x 94	= 94 pounds
1 part lime	= 1 x 40	= 40 pounds
6 part sand	= 6 x 85	= 510 pounds
Totals	= 8 cubic feet	644 pounds

In other words, one cubic foot of type N mortar weighs  $644 \text{ pounds} \div 8 = 80.5 \text{ pounds per cubic foot}$ .

*For more mortar descriptions see ASTM spec. C270-86 b. There are many specialized mortar uses, such as chimney, reinforced masonry, and acid-resistant mortars. (American Society for Testing and Materials.)*

## Guide for the Selection of Masonry Mortars

### Exterior, above grade

Load-bearing wall

Recommended mortar      Type N

Alternative mortar      Type S or M

### Exterior, above grade

Non-load bearing wall

Recommended mortar      Type O ♦

Alternative mortar      Type N or S

### Parapet wall

Recommended mortar      Type N

Alternative      Type S

### Exterior at or below grade

Foundation, retaining wall,  
manholes, sewers, pavements,  
walks, and patios

Recommended mortar      Type S ♥

Alternative mortars      Type M or N ♥

### Interior

Load-bearing wall

Recommended mortar      Type N

Alternative mortars      Type S or M

Non-bearing partitions

Recommended mortar      Type O

Alternative mortar      Type N

♦ Type O mortar is recommended for use where the masonry is unlikely to be frozen when saturated or unlikely to be subject to high winds or other significant lateral loads. Type N or S mortar should be used in other cases.

♥ Masonry exposed to weather in a nominally horizontal surface is very vulnerable to weathering. Mortar for such masonry should be selected with due caution.

**Mortar testing =**

On the job, the freshness and spreadability of the mortar can be quickly tested with the trowel. Using the point of the trowel, pull the mortar into small, sharp ridges. If the ridges hold, the mix (in terms of the amount of water) is well proportioned. If there is too much water, the ridges will run down and slump. If there is not enough water, the ridges will break and crumble. Good mortar has the consistency of soft mud.

**Muriatic acid =**

Acid solution used for cleaning masonry work. A solution of hydrochloric acid.

**Nominal dimension =**

The size of a building unit in place with mortar, as opposed to the actual, measured size of the unit.

**Opus quadratum =**

Masonry of squared stones in regular ashlar courses.



**Opus reticulatum =**

A decorative Roman wall facing, backed by a concrete core, formed of small pyramidal stones with their points embedded in the wall, their exposed square bases set diagonally, forming a net-like pattern



**Overhand work =**

Laying of brick from inside a wall.

**Panel (masonry) =**

Building unit constructed of masonry units. Masonry panel is delivered on the job in one unit and is hoisted into place in the building.



**Parapet =**

Wall section that extends above the roof; normally associated with a flat roof.

**Parge - pargeting - parging =**

Process of applying a coat of mortar to masonry construction, especially used for masonry walls. The purpose is to provide an even surface of further finishing.



**Party wall =**

A wall used jointly by two parties under easement agreement, erected upon a line dividing two parcels of land, each of which is a separate real estate entity; a common wall.

**Paver - paving - paving brick =**

1. Special brick, adobe, tile, stone, or solid concrete unit used for floors, walls, and patios. Concrete pavers are shaped with interlocking sides.
2. Laying flat masonry units in ground. Also placing of concrete on the ground
3. Bricks especially suitable for use in pavements.

(ASTM Specification C902)

**Pick and dip =**

A method of laying brick whereby the bricklayer simultaneously picks up a brick with one hand and, with the other hand, enough mortar on a trowel to lay the brick.

**Pitch-faced =**

In masonry, having all aris cut true and in the same plane, but with the face beyond the aris edges left comparatively rough, being simply dressed with pitching chisel.



**Plumb - plumb bob - plumb bond - plumb pole =**

1. Exactly vertical. 2. A shaped metal weight which is suspended from the lower end of a line to determine the vertical. 3. In masonry, any bond in which the vertical joints are precisely in line. 4. A pole used to ensure that the vertical joints are plumb.



**Pointing - tuck pointing - tuck and pat pointing =**

1. Filling mortar into the joint after the masonry units are laid; filling of raked-out joints.
2. Refilling of old masonry joints that have been raked out and cleaned.
3. The finishing of old masonry joints after cleaning and filling with fine or with a fillet of putty or lime; also called tuck and pat pointing mortar which is left projecting slightly.

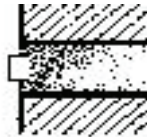

**Projecting brick =**

One of a number of bricks which project beyond the face of a wall, usually forming a pattern.



**Puddling =**

Settling of grout in masonry wall by agitating the mixture with a stick or rod; intended to remove air voids in the grout.

**Quarry - quarry-faced - quarry run - quarry sap =**

1. Open stone or clay pit. 2. Descriptive of the freshly split face of ashlar, as it comes from the quarry, squared off only for the joints. 3. Building stone as it is supplied by the quarry, unselected for color and texture. 4. The natural moisture in stone as it comes from the quarry ledge; varies in amount with the porosity.



**Queen closer - queen closure =**

A brick which has been cut in half along its length; it is of normal thickness but half normal width; used to complete a course or to space normal size bricks.



**Quicklime =**

Caustic lime made of calcium oxide made by heating carbon dioxide off lime stone.

**Quoin - coing - coin =**

Large square stone of brick set at the corner formed by two masonry walls. Projects out from the corner in some cases.

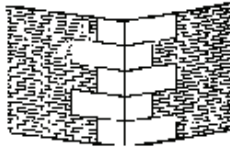

**Racking =**

Laying or stepping back each higher masonry course.

**Raggle =**

Groove or slot in a masonry unit; slot is cut along one side to receive the edge of the flashing. Also *reglet*.

**Ragwork =**

Crude masonry, laid in a random pattern of thin-bedded, undressed stone. Polygonal rubble which is set on edge as exterior facing.



**Rake out - raking =**

Cleaning out mortar from a joint; both fresh or old.

**Random work - random range work =**

Masonry of rectangular stone not laid in regular courses, but broken up by the use of stones of different heights and widths, fitted closely.



**RBM =**

Reinforced -Brick-Masonry.

**RGMB =**

Reinforced-Grouted –Masonry-Brick.

**Retarder =**

Mortar additive that slows down setting.

**Retemper =**

To remix mortar by adding more water.

**Revetment =**

Same as parging.

**Rich mortar =**

Mortar high in cementitious material.

**Rip block =**

Concrete block not in full height.

**Rise =**

Vertical direction.

**Rowlock =**

Masonry units laid on face edge with end facing out. Also spelled *rolok*.



**Rubbed joint =** Flushed mortar joint; joint is rubbed flat to the face of the masonry units.

**Rubble - rubblework =**

1. Rough, irregular stone. 2. Stone masonry built of rubble.



**Run =** Horizontal direction.

**Sag =**

To fall below the horizontal line.

**Sailor =**

Brick laid on end with the large or bed side facing outward.

**Salmon brick =**

A poor quality brick that lacks weather resistance; so named because of its pink color; commonly used to fill spaces.

**Saturation coefficient - C/B ratio =**

The amount of cold water absorbed by a brick to the amount of boiling water absorbed. Indicator of how a brick will react to freezing and thawing cycle.

**Saturation line =**

A line indicating the ground water level.

**Scratch coat =**

First or base coat of a two-coat plastering or parging. Coat is scratched to form a good bonding surface for the finish coat.

**Serpentine =**

Wall that curves back and forth.



**Set - setting - setting up =**

Hardening of mortar; in initial set, mortar reaches a partial strength; in final set, the full specified hardness is attained. **2.** Laying masonry units in place. **3.** Hardening of mortar.

**Shiner =**

Brick set on the face side with the large or bed side facing out.

**Shoved joint =**

Joint made by shoving end of one brick against another in the mortar bed.

**Sill - sill course =**

1. Bottom of a window or door frame.
2. A stringcourse set at windowsill level; commonly differentiated from the wall by its greater projection, its finish, or its thickness.



**Skew - skewback =**

1. To twist back or lean; to incline.
2. Inclined surface at end of arch where arch joins the supporting wall.

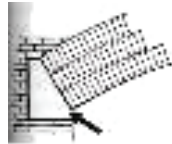

**Slack to the line =**

Masonry units set too far back from the guideline.

**Slaking =**

Adding water to hydrate lime.

**Slaked lime =**

Quicklime with water added.

**Slump test =**

A slump test measures how easy a concrete mix will be to work with. The figure below shows

how to make a slump test using a 12-inch-high sheet metal cone that is open at both ends. The bottom of the cone is 8 inches in diameter, and the top is 4 inches in diameter.

Start the slump test by moistening the inside of the metal cone. Then place the cone on a flat smooth surface with the large end down and fill it with concrete sample in three layers. Tamp each layer before you add the next. After the cone is completely full, lift the cone so the wet concrete slumps down. Measure the height of the concrete cone. Subtract this height from the original 12-inch height to give the slump.

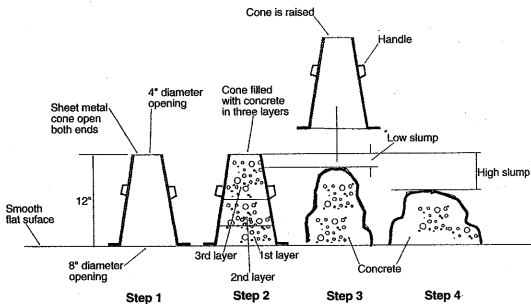

If the number is high, the concrete is a wet mix.

If it's low, the concrete is a dry mix.

Recommended slumps for different types of concrete work are shown in the chart below.

If the concrete is not thoroughly vibrated (tamped), increase the values in the table by 50%.

However, the slump should never be more than 6 inches.

<b>Type of concrete work-slump</b>	<b>Max. inches</b>	<b>Min. inches</b>
<b>Reinforced foundations</b>	<b>4</b>	<b>2</b>
<b>Plain foundations &amp; caissons</b>	<b>3</b>	<b>1</b>
<b>Slabs, beams, walls, columns</b>	<b>5</b>	<b>2</b>
<b>Pavements</b>	<b>2</b>	<b>1</b>
<b>Mass concrete</b>	<b>2</b>	<b>1</b>

Only a little water is needed to start the chemical reaction in cement. Water/cement ratios may go from 0.25 for high-strength concrete, to 0.55 for low-strength mix.

**Slurry =**

Runny or liquid cement mixture; used for thin-coating a masonry surface. Also called *wash*.

**Slushed joint =**

Joint filled after brick is laid. (*unprofessional practice*)

**Soldier =**

Brick or concrete block set on end with face oriented toward the outside.

**Spall =** A fragment or chip that has fallen from a masonry surface by rusting of the rebar or by action of the elements.

**Span =**

Distance between two supports.

**Spandrel =**

Triangular area on each side of an arch. Also a support unit between columns or piers.

**Splay =**

Slanted or beveled surface.

**Split =**

To split or break a masonry unit lengthwise parallel to the bed side.

**Stiff mortar =**

Low water mortar; a drier mortar.

**Storypole =**

Stick or pole marked with key masonry height that is used as a guide when laying corners.

**Stretcher =**

Masonry unit laid lengthwise on its bed; the face side faces out.

**Striking =**

Tooling or jointing a mortar joint.

**Stringing mortar =**

Spreading out a mortar bed for the laying of several units.

**Stripped joint =**

A type of raked joint, used with bricks of rough texture.



**Struck joint =**

Mortar joint that has been finished with a trowel and is beveled in at the bottom.

**Structural clay unit =**

Fired masonry unit such as brick or tile.

**Suction rate =**

Ability of a material, such as brick, to absorb water. Also called *initial rate of absorption*.

**Surface bonding =**

Method of laying concrete block in a wall without mortar in the joints; wall is coated with a special surface bonding mortar containing fiberglass.

**Synthetic stone =**

Manufactured stone.

**Tailing the lead =**

Aligning masonry courses on a corner so they are straight and level.

**Temper =**

Adding water to mortar; to moisten and mix to a proper consistency.

**Template =**

Shaped pattern or guide used when forming or laying brick to follow a specific shape.

**Tender =**

Laborer who helps a mason, for example, by bringing mortar or brick.

**Tensile strength =**

The resistance to force that pulls apart a material to rupture; the maximum *tensile stress* which the material can sustain.

**Tension =**

Force tending to pull material apart, as on the bottom of a lintel or beam. A stretching force.

**Terra cotta =**

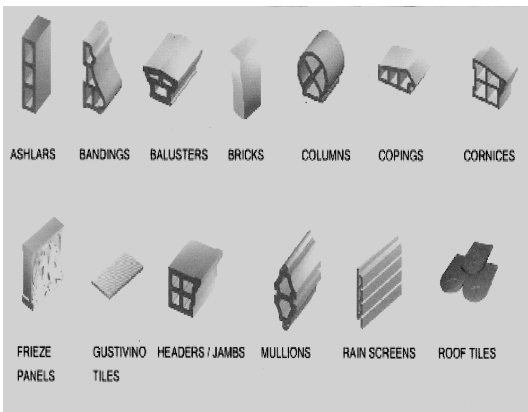

Clay that has been molded in shape and then treated in a kiln at high temperature; typically reddish-brown in color when unglazed; when glazed, usually colored and used for ornamental work. After the first half of the 19<sup>th</sup> century, terra cotta became an economical alternative to stone as an exterior cladding material. Terra cotta cladding is difficult to waterproof as there is no membrane behind and it depends entirely on the joints to keep the water from penetrating the substrate.

**Throat =**

Opening at top of fireplace through which the smoke flows.

**Through stone =**

A stone that is set with its longest dimension perpendicular to the face of a wall and whose length is equal to the thickness of the wall.



**Through-wall flashing =**

A flashing which extends through a wall, from one side to the other.

**Throwing the mortar joint =**

Applying mortar to the end of a brick with a sweeping motion.

**Tie =**

Masonry unit or metal piece used to tie walls together or used to tie a masonry wall to some other structural base.

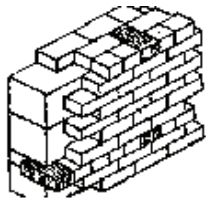

**Tier =**

A row, or a group of rows placed one above the other as a wythe.

**Tile =**

Hollow masonry unit made of fired clay, shale, or some mixture of these.

**Tile setter—tile setting =**

1. One who sets tile. 2. Setting tiles into an adhesive mortar by a tile setter.

## Tools (masonry)

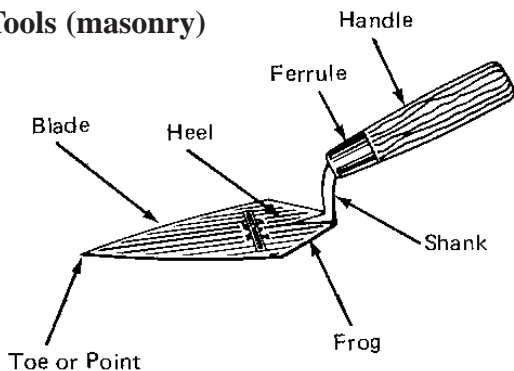

**Float**



**Pointing Trowel**

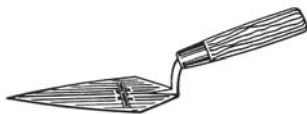

**Pointing /Caulking Trowel**



**Jointer**



**Combing tool**



**Stone Plane**

# Chisels

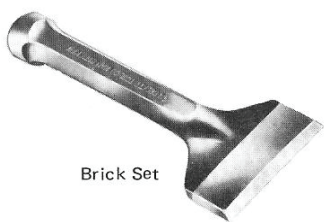
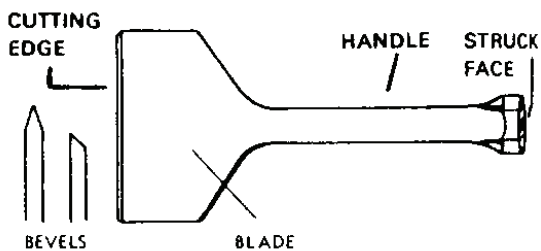

Brick Set

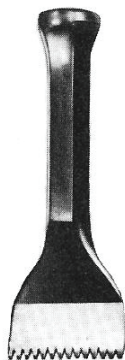

Tooth Chisel



Pitching Tool

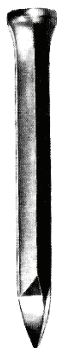

Point Chisel

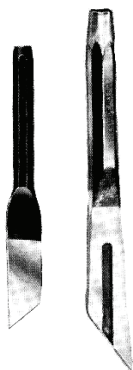

Plugging Chisels

## Hammers

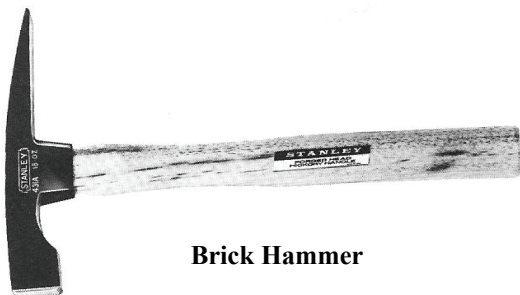

**Brick Hammer**

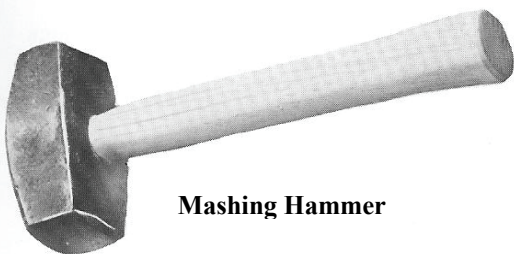

**Mashing Hammer**



**Stone Mason Hammer**



**Bush Hammer**



HALF ROUND

Sled runner



Joint rakers



Line blocks

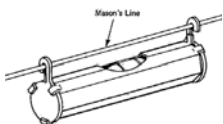

Line level

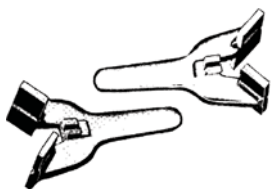

Corner blocks

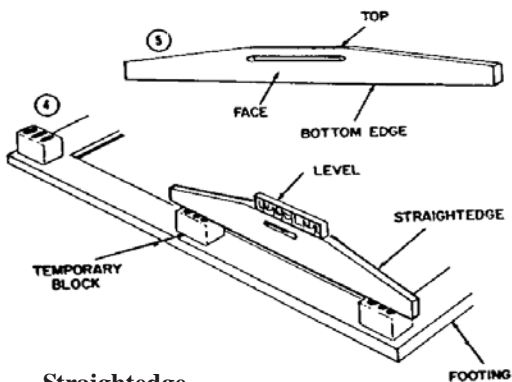

Straightedge

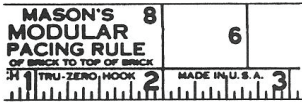

## Modular spacing rules

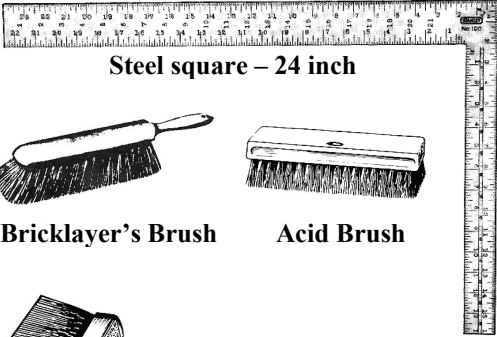

Steel square - 24 inch



Bricklayer's Brush



Acid Brush



All purpose brush

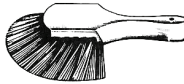

Acid Brush



Wire Brush

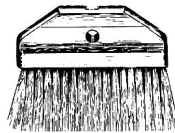

Acid Brush

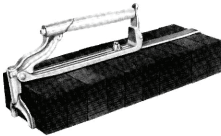

Brick tongs



Mortar board

**Tooling =**

Compressing, shaping, or finishing of mortar joints with a special finishing tool. Also jointing.

**Toothing =**

Temporary wall end where alternate stretchers project out. Projecting masonry units are called tooth.

**Trig =**

Device used for supporting a line at the center of a wall.

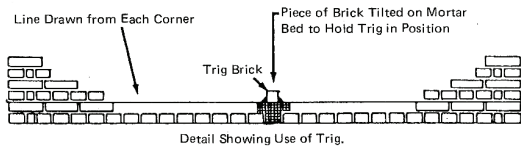
**Trim =**

Masonry or stone facings; sills or coping.

**Trimming =**

Cutting of stone or masonry units on different sides to a specified dimension or shape.

**Tuckpointing =**

Refilling of old masonry joints that have been raked out and cleaned. ( see pointing)

**Veneer =**

Separate wythe of masonry that has no structural function and is attached to the structural face of the building or another wall.

**Vitrified =**

Glassy in appearance. A fired clay that has been fused together. Commonly used on the face of terra cotta units.

**Voids =**

Openings, cells, cores, or holes in a masonry unit.

**Water Retentivity =**

The ability of mortar to hold water to prevent rapid loss to masonry units with high degree of absorption or suction.

**Water Table =**

A horizontal exterior ledge on a wall, pier, buttress, etc.; often sloped and provided with a drip molding to prevent water from running down the face of a structure. Also **groundwater level**.

**Web =**

Solid wall section between cores in a masonry unit; commonly used to describe the solid wall between concrete block cells.

**Weep Holes =**

Openings in masonry joints left at the base of a masonry wall so moisture can escape.

**Winning =**

Digging and mining of clay or shale.

**Wythe =**

One masonry unit in thickness.

**END CHAPTER IV**

## V. STONES – ORIGIN AND USE

### Definition of Stone:

A stone is any type of rock that has been selected or processed by cutting shaping, or sizing for use as building material or for decorative purposes.

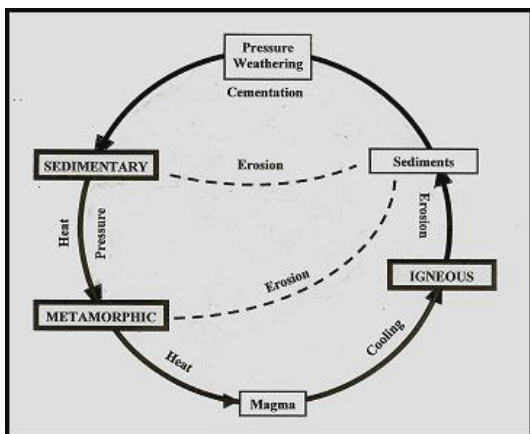

### Characteristic of Stone in General:

Rocks are the result of a constant and endless cycle that spans hundreds of millions of years. The rocks and their constituent minerals are constantly changing form in a prescribed pattern as traced above. This cycle summarizes the relationship between the different rock forms: **igneous, sedimentary and metamorphic.**

Not all rocks proceed through each step, however. The cycle merely describes the possible avenues of change that rock can follow. James Hutton wrote: “*no vestige of a beginning – no prospect of an end.*”

### From magma to rock:

When magma pours out of the Earth from volcanoes and dikes, it hardens rapidly as extrusive (volcanic) **igneous** rock. (This is the beginning of the stone process.)

Over time, wind and rain can reduce all rock to sediment, including deeply buried intrusive rock, which is first exposed by erosion. Chemical bonding and pressure from above compact the sediment, transforming it into **sedimentary** rock. (These are products of erosion and weathering).

The changes do not stop there. Extremely high heat and pressure can gradually alter all rocks into another type of rock, the **metamorphic** rock.

The full circle is completed when rocks of all kinds are buried deep enough for the heat of the Earth's core to melt them into magma once again.

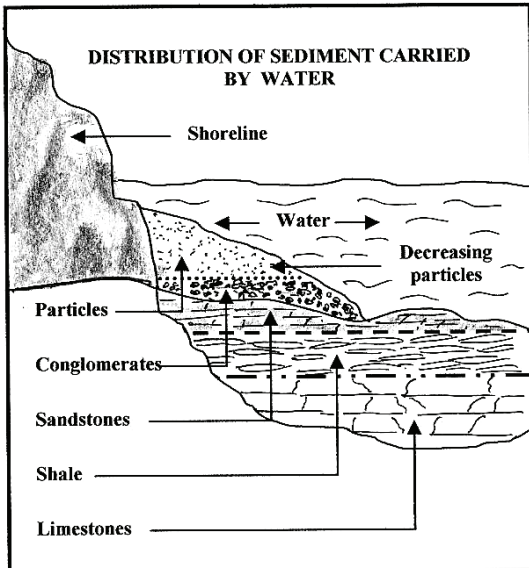

	Quartz	Field-spar	Clay	Calcite Dolomite	Iron Oxides
Sandstone	70%	8%	9%	11%	1%
Shale	32%	18%	34%	8%	5%
Limestone	4%	2%	1%	93%	-

A basic understanding of stone formation is useful when required to repair or maintain them.

### **Types of stones:**

#### **1. Igneous**

Andesite, Basalt, Diorite, Feldspar, Gabbro, Granite, Granodiorite, Nepheline Syenite, Obsidian, Peridotite, Pumice, Rhyolite, Trachyte and Tuff.

#### **2. Sedimentary**

Breccia, Chalk, Chert, Coal, Conglomerate, Dolomite, Flint, Graywacke, Limestone, Mudstone, Rock Salt, Sandstone, Shale and Travertine.

#### **3. Metamorphic**

Anthracite, Eclogite, Granulite, Hornfels, Marble, Migmatite, Quartzite, Serpentine and Slate.

Geologists further their classifications as: intrusive, extrusive, acidic, basic, ultra-basic, intermediate etc.

In our trade, we will mainly deal with: **Basalt, Gabbro, Granite, Limestone, Marble, Sandstone and Slate.**

## **Intended uses of stone as a building material:**

- a. As a load-bearing masonry structure.
- b. As cladding.
- c. As flooring and paving materials.
- d. As landscaping.
- e. As ornamental units.
- f. As casework and furniture.

## **Deterioration and Problems with stones:**

- a. Environmentally related deterioration:
  1. Delamination
  2. Spalling
  3. Salt Crystallization
  4. Discoloration – Staining
  5. Organic Growth
  6. Fracturing due to corrosion of metal anchorages
- b. Deterioration of adjacent building materials:
  1. Mortar joints
  2. Sealant joints
  3. Flashings
- c. Stress related deterioration:
  1. Cracking due to settlement
  2. Cracking due to thermal movement.
  3. Cracking due to shrinkage.
- d. Inappropriate repairs:
  1. Incompatible repair material
  2. Improper preparation and workmanship
  3. Improper repairs (sealants, mortars, etc.)

## How to inspect and analyze the damage:

a. Visual inspection



b. Tapping and sounding



c. Infrared scanning



d. Metal detection



e. Laboratory analysis



### **Find the cause of the problem!**

Besides the above, the review of the history of the structure, the available drawings and documentation is most important. The time spent on research has been invaluable in successful projects. The study of construction documents will reveal some causes of existing failures. Bear in mind that often the actual installation does not correspond with the drawings.

## How to repair or restore a stone structure:

- a. Patching
- b. Retooling (polishing or honing)
- c. Temporary stabilization
- d. Supplemental anchorage
- e. Crack repairs
- f. Dutchman
- g. Unit replacement
- h. Consolidation
- i. Cleaning (appropriate procedures and materials)
- j. Cutting and repointing of mortar joints
- k. Installation of sealants



A restored structure should look like a lady who has aged gracefully and has been well kept.

To achieve this, the repairs become the most important phase of restoration or preservation.

All repairs should be:

1. **Sound** (Well anchored and structurally solid.)
2. **Compatible** (The repairs have to marry the existing materials in density and movements.)
3. **Blending** (The profile details, the texture and colors should blend with the surrounds.)

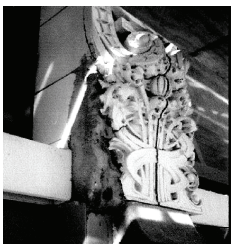

Typical bad repair

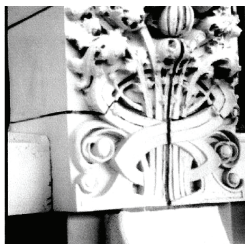

Good blending repair

## **Patching**

*In stone and masonry* = Using a compound to fill voids or to replace chips and broken corners or edges of cut stones or fabricated masonry units. It is applied in plastic form; mixed or selected to match the color and texture of the damaged unit.



### **Patching using repair mortar and carving**

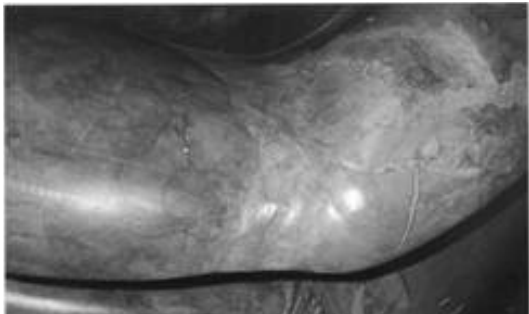

### **Then blending the color and texture**

Patching materials and procedures may be governed by national or local historic registration of the building or monument.

## **Retooling (polishing or honing)**

*Imparting a natural stone by a rubbing process, either hand or mechanical. Using a tool to recreate the original tooled finish or tolled surface.*



### **Honing mechanically**

## **Temporary Stabilization**

*Improving temporarily the stability of loose or unstable units.*

Shoring, securing, pinning or covering an unstable unit until it can be permanently repaired or replaced.

## **Supplemental Anchorages**

*Adding anchorages to units having insufficient or rusting existing anchorage.*

Re-anchoring the unit to the backing substrate using stainless steel threaded rods set in epoxy or stainless steel strap anchors does this generally. Such anchors should be specified and designed by an engineer.

## Crack Repairs

*Repair of a complete or incomplete separation within a single element or between contiguous elements of constructions.*

Cracks in stones or masonry units are very dangerous and not easily repaired as they affect the structural integrity and the watertightness of the unit. To restore the structural integrity it may be necessary to inject epoxies or install pins. The restoration of the watertightness is done with sealant installation or pointing and matching the color and texture.

## Dutchman

*A piece of similar material used to replace a damaged or missing portion of a natural stone or masonry unit.*

The cut is made to fit exactly the shape and size of the Dutchman allowing the smallest possible void for the installation of the mortar or epoxy. A successful Dutchman should be structurally sound and blend with the repaired unit.

## Unit Replacement

*Substitution of a damaged unit with a new unit of the same composition and detail.*



**Damaged**

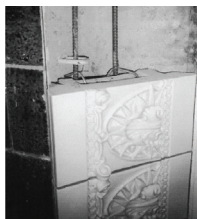

**Replaced**

There are a lot of arguments on this subject. In stone or brick construction where units are under compressive stress and replacements are easily available, the replacement is a viable option. It is relatively easy to replace a few bricks or stones after finding a good match and using compatible mortars.

In Terra Cotta cladding, it is a different story. The replacement of units that cannot be anchored in a conventional or original way poses several problems.

- A. New units matching the existing are not easily obtained and take time to make them. It is not economically feasible for a manufacturer to stop production to cast and fire a few units.
- B. Usually, they cannot be installed and anchored with the conventional system. They require pinning and often grouting of the cells, which then changes the structural consistency of the wall.
- C. After all the drilling, patching and blending, you no longer have a new unit.

In cases where the installation of new units creates more problems than it solves, the repair provides a better and more economical result.

## **Consolidation**

*The process of injecting fluid grouting into stones or masonry units by continued pressure to eliminate voids and reinforce weak or unstable areas.*

This is a costly and complex procedure that requires studies that cannot be covered here.

## Cleaning (procedures and materials)



*The removal of all foreign matter from the stone, masonry unit and mortar. This is usually the first phase of a restoration or preservation project. It will establish the criteria of the colors and textures to match when repairing the damaged stones. Sometimes, contractors prefer to do the cleaning last. However, a mock-up should be performed first to establish the criteria.*

Cleaning is probably the most important phase and the most misunderstood procedure. More damage is done during the cleaning operation than any other phase of restoration. Too often the cleaning phase is rushed and destructive. Instead of starting with the gentlest type of cleaning, the contractor will often start with the most abrasive type and severely damage the stone. Cleaning methods should be ***only strong enough to do the required job and no more***. When using cleaning products focus on the pH; this is the concentration of hydrogen ion in a solution. A small change in the pH value is a large change in concentration of hydrogen.

Cleaning requires a good knowledge of the stones. Quartz stones have a greater resistance to acids and high alkaline detergents. Granite, which is primarily quartz, will take aggressive cleaning without damaging the stone; limestone will not tolerate any cleaning agent because of its calcium content.

When using detergents, poultices and diluted acids solutions, watch the pH.

# pH = MEASURE OF SOLUTION ACIDITY

pH	Solutions	Acid	
0.0	Hydrochloric Acid		+ A C I D I T Y
1.0	Gastric juices		
2.3	Lemon juice		
2.9	Vinegar		
3.5	Wine		
4.1	Tomato juice		
5.0	Black coffee		
5.6	Acid rain		
6.0	Urine		
6.5	Rainwater		
6.6	Milk		
7.0	Pure water	Neutral	
7.4	Blood		+ A L K A L I N E
8.7	Baking Soda		
9.2	Borax solution		
10.5	Milk of magnesia		
11.0	Lime water		
11.9	Household ammonia		
14.0	Sodium Hydroxide	Alkaline	

## **Repointing of mortar joints**

*The removal of defective mortar from between the joints of masonry units and the replacing it with new mortar.*

See page 48 for types of joints.

The mortar is not intended to tie the units together, but to separate them. The units need to move independently. Thus it is important that the mortar be softer than the units.

## **Sealant installation**

Installation of material or devices used to prevent the passage of liquid or gas across a joint or opening.

Sealant is used instead of mortar where movement is anticipated. Sealant will allow the movement but will prevent the water intrusion. The installation of sealant is critical.

Please refer to Chapter III – SEALANTS.

## **Maintenance**

It is not uncommon to hear that natural stones do not require maintenance. If this would be the case, our Roman structures would still be standing or would not need extensive restoration today. The proper choice of stones for specific application is vital and the proper protection of the stones to prevent water intrusion is also necessary. *Nothing lasts forever-not even the stones.*

## **END OF CHAPTER V**

## VI. LANDMARK ELEMENTS ILLUSTRATIONS - DESCRIPTIONS

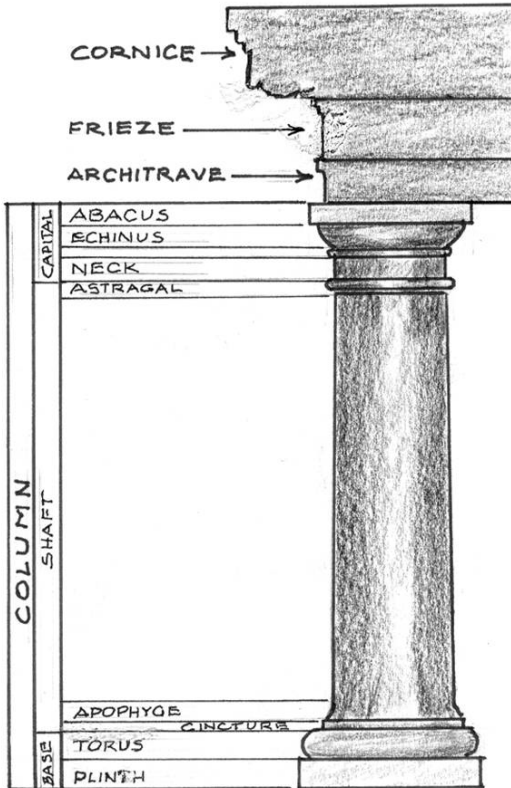

It is extremely important, in my opinion, that anyone involved in restoration or preservation should be able to identify and properly describe the various elements or components that one is attempting to repair or replace.

Too often, I have heard, “ *I am fixing the bottom of the column at the front of the church*” instead of “ I am repairing the torus on the west column of the transept”. The lack of proper designation and placement has often resulted in mistakes, such as doing the wrong column or the wrong component of that column.

The supervising conservator will not respect the best craftsman if he or she uses an incorrect term to describe a specific component. Naturally, it is very difficult for a craftsman to study and remember the terminology of all landmark components he or she will be required to repair or replace.

For this purpose, I have provided an alphabetical inventory of the elements that you will likely encounter in the restoration trade in the United States. It is an easy reference, readily available that you will enjoy and should allow you to gain the respect of the supervising professionals.

If you fail to find a component in this handbook, I suggest that you refer to the Dictionary of Architecture & Construction by Cyril M. Harris, Third Edition.

The following illustrations and description are taken from the Dictionary of Architecture & Construction by Cyril M. Harris, The Library of Congress and my personal drawings.



**abacus**

**abacus =**

The uppermost member of the capital of a column, often a plain square slab, sometimes molded or otherwise enriched.

**abutment =**

A masonry mass (or the like) which receives the thrust of an arch, vault, or strut.

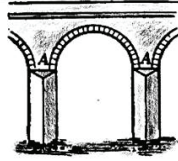

**abutment "A"**



**acanthus**

**acanthus =**

A common plant of the Mediterranean whose stylized leaves form the characteristic decoration of Corinthian and Composite orders.

**accolade =**

An ornamental treatment, used over an arch, a door, or a window, composed of two ogee curves meeting in the middle; often a richly decorated molding.

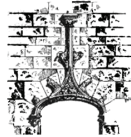

**accolade**



**acorn**

**acorn =**

A small ornament in the shape of a nut of the oak tree; sometimes used a **finial**, **pendant** or as a decorative element within a broken pediment, or as a decoration on a carved panel.

**acroterion – acroterium =**

Strictly a pedestal at the corners or peak of a roof to support an ornament.

More usually, the ornament itself.



**acroterion**

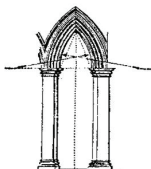

**acute arch**

**acute arch, lancet arch =**

A sharply pointed arch whose centers are farther apart than the width of the arch.

**aegiranes =**

Sculptured representation of the heads or skulls of goats or rams; used as decorations on ancient altars, friezes, etc.



**aegiranes**



**agrafe**

**agrafe =**

The voussoir or keystone of an arch, especially when carved as a cartouche.

**allège =**

A part of a wall that is thinner than the rest.

The spandrel under a window.



**allège**



**allure**

**allure, allure, alur =**

A gallery or passage, as along the parapets of a castle, around the roof of a church, or along a cloister.

**ambry, almar, almary =**

A cupboard or niche in a chancel wall for the utensils of the Eucharist, an armanium. A storage place, storeroom, closet or pantry.



**ambry**



**amortizement**

**amortizement =**

The sloping part of a buttress or projecting pier.

**ancon, pl. ancones =**

A scrolled bracket, which supports a cornice or entablature over a door or window. A projecting boss on a column drum or wall block.



**ancon**



**Anglo-Saxon**

**Anglo-Saxon architecture =**

The pre-Romanesque architecture of England before the Norman Conquest (1066 AD). Massive walls and round arches: long-and-short work.

**antefix =**

A decorated upright slab used in classical architecture to close or conceal the open end of a row of tiles, which cover the joints of roof tiles.

A similar ornament on the ridge of a roof.



**antefix**



**anthemion**

**anthemion =**

A common Greek ornament based upon the honeysuckle or palmette. Used singly on stelae or antefixes, or as a running ornament on friezes, etc.

**antic, antic work =**

A grotesque sculpture consisting of animal, human, and foliage forms incongruously run together and used to decorate molding terminations and many other parts of medieval architecture. Sometimes synonymous with **arabesque**.



**antic**

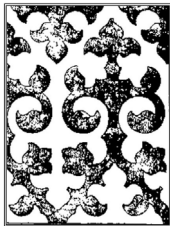

**arabesque**

**arabesque =**

Overall decorative pattern of acanthus scroll, swags, candelabrum shafts, animal or human forms, on panels or pilasters, in Roman and Renaissance architecture. A specie of ornament of infinite variety used for enriching flat surfaces or moldings, painted, inlaid or carved.

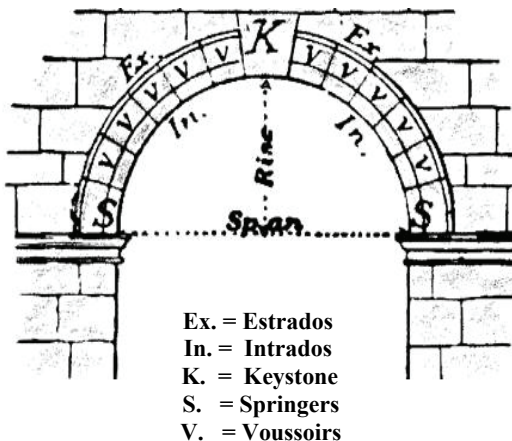

### Arch =

A construction that spans an opening; usually curved; often consists of wedge-shaped blocks (**voussoirs**) having their narrower ends toward the opening. Arches vary in shape, from those that have little or no curvature to those that are acutely pointed.

### Types =

Acute, anse de panier, arriere voussure, back, basket-handle, bell, blind, camber, catenary, cinquefoil, compound, cusped, diminished, discharging, Dutch, elliptical, equilateral, flat, Florentine, foil, French, garden, gauge, Gothic, horseshoe, inverted, jack, keel, keystone, lancet, Mayan, memorial, miter, Moorish, ogee, pointed, Queen Anne, raking, rampant, rear, relieving, round, rowlock, safety, sconcheon, secondary, segmental, semicircular, semielliptical, shouldered, skew, straight, three-centered, transverse, trefoil, triangular, triumphal, Tudor, and two-centered arches.

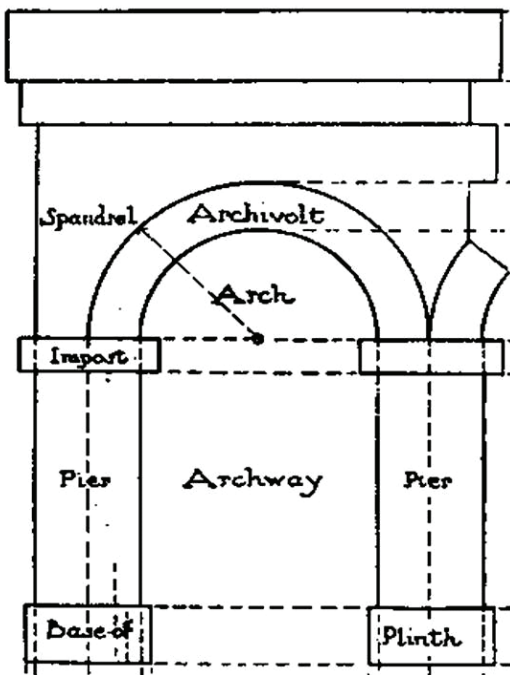

**archway =**

A passage through or under an arch.

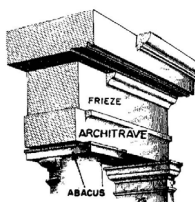

**architrave**

**architrave =**

In the classical orders, the lower member of the **entablature**; the beam that spans from column to column, resting directly upon their capitals.

The ornamental mouldings around the faces of the jambs and lintel of an opening; an antepagment.

**arrière-voussure, rear arch =**

A rear vault ; an arch or vault in a thick wall carrying the thickness of the wall, esp. one over a door or window frame.

A relieving arch behind the face of a wall.

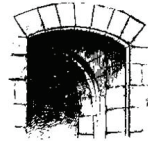

Arrière-voussure



arrow loop

**arrow loop, loophole =**

A vertical slit for archers in medieval fortification walls, with jambs deeply splayed toward the interior.

**astragal =**

A bead usually half-round, with a fillet on one or both sides. It may be plain but usually it is the classical molding consisting of a small convex molding decorated with a string of beads or bead-and-reel shapes.

A plain bead molding, also called a baguette or chaplet.

A member, or combination of members, fixed to one of a pair of doors or casement windows to cover the joint between the meeting stiles and to close the clearance gap; provides a weather seal, minimize the passage of light and noise, and retards the passage of smoke or flame during a fire.



astragal – Greek Arch.

**atlas, pl. atlantes =**

A figure (or figures) of a man used in place of a column to support and entablature; also referred to as a telamon.



atlas

**attic =**

In classic building, a story built above the wall cornice. Pertaining to the district of Attica in Greece.

The space between the ceiling framing and the underside of the roof framing.

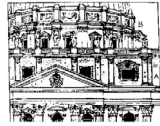

**attic**



**balistraria**

**balistraria =**

In medieval battlements, a cross-shaped aperture through which crossbowmen shot their arrows.

**ballflower =**

A spherical ornament composed of three conventional petals enclosing a ball, usually in a hollow molding, popular in the English Decorated style.



**ballflower**

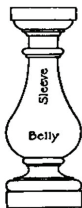

**baluster**

**baluster, banister =**

One of a number of short vertical members, often circular in section, used to support a stair handrail or a coping.

**balustrade =**

The entire railing system including top rail, balusters and bottom rail.

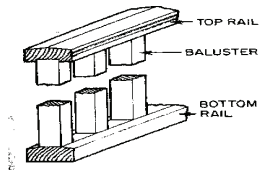

**balustrade**

**base =**

Lower part of a column or pier, wider than the shaft, and resting on a plinth, pedestal, podium, or stylobate.

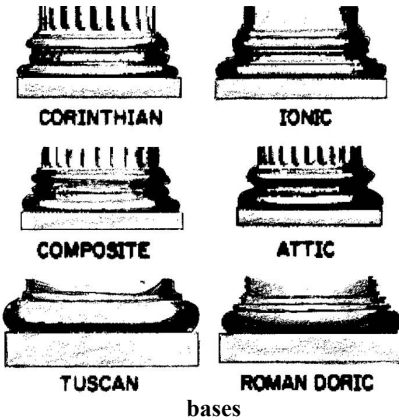

**basilica =**

The form of the early Christian church, a central high nave with clerestory, lower aisles along the sides only, with semicircular apse at the end.

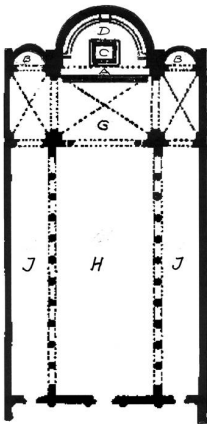

- D = apse
- B.B. = secondary apse
- C. = high altar
- D. = bishop's throne
- G. = transept
- H = nave
- J.J. = aisles

**basket-handle arch =**

A flattened arch whose ellipse-like shape is determined by three arcs that are interconnected.



**basket-handle arch**



**bead and reel**

**bead and reel =**

A semiround convex molding decorated with a pattern of disks alternating with round elongated beads.

**bell =**

The body of a Corinthian or a Composite capital, with the foliage removed; also called a vase or basket.

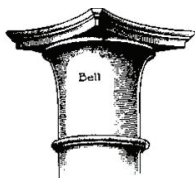

**bell**



**bell arch**

**bell arch =**

A round arch supported on large corbels, giving rise to a bell-shaped appearance.

**belvedere =**

A rooftop pavilion from which a vista can be enjoyed.

(Belvedere of the Vatican)

A gazebo, a mirador.

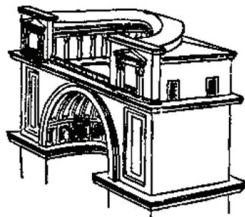

**belvedere**

**bezant, besant, byzant =**  
An ornament shaped like a coin or a disk; sometimes used in a series in decorating molding designs.



**bezant**



**bifrons**

**bifrons =**  
Having two fronts or faces looking in two directions, as a double herm.



**billet**

**billet =**  
A common Norman or Romanesque molding formed by a series of circular or square cylinders, disposed alternately with the notches in single or multiple rows.



**blind arcade**

**blind arcade =**  
A row of arches applied to a wall as a decorative element, esp. in Romanesque building.

**blunt arch =**

An arch rising to a slight point, struck from two centers within the arch.



**blunt arch**



**boss**

**boss =**

A projecting, usually richly carved, ornament placed at the intersection of ribs, groins, beams or at the termination of a molding.

**bracket =**

Any overhanging member projecting from a wall of other body to support a weight. Also see eaves bracket, stair bracket, step bracket and wall bracket.



**bracket**



**Bracketed hood**

**bracketed hood =**

A projecting unit over a window or door that is supported by brackets, providing some shelter or serving as ornamentation.



**broken  
pediment**

**broken pediment =**

A pediment whose sloping or curving sides terminate before reaching the highest point, resulting in an opening that is often filled with an ornament.

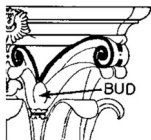

**bud**

**bud =**

A typical element of a Corinthian capital.

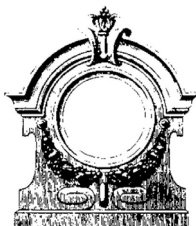

**oeil-de-boeuf**

**bull's-eye =**

A round or oval aperture, open, louvered, or glazed: an **oculus** or **oeil-de-boeuf**.

A figure or ornament of concentric bands.



**cable  
molding**

**cable molding, cabling =**

An ornament formed like a cable with twisted strands.

The convex filling of the lower part of the flutes in classical columns.

**canton =**

A corner of a building decorated with a projecting masonry course, a pilaster, or similar feature.



**canton**

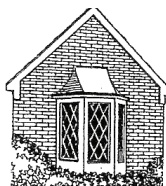

**cant  
window**

**cant window =**

A bay window erected on a plan of canted outline; the sides of the window are at an angle with respect to the wall; also called **angle bay window**.

**capital =**

The topmost structural member of a column

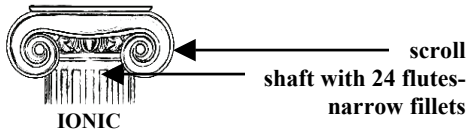
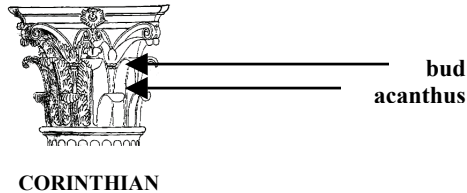
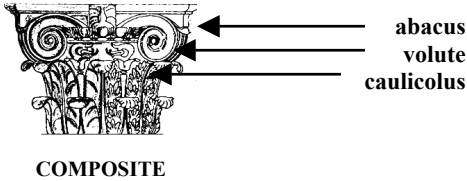
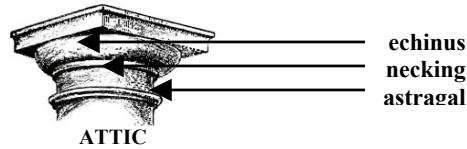

The Doric order was developed by the Dorian Greeks. Sturdy proportion but plainer than the Ionic.



It is a simplified version of the Roman Doric order.

**cartouche =**

An ornament tablet, often inscribed or decorated, and framed with elaborate scroll-like carving.



**cartouche**



**catshead**

**catshead =**

An ornament consisting of an animal-like head.

**cavetto =**

A hollow member or round concave molding containing at least the quadrant of a circle, used in cornices. Often erroneously called “scotia” which has noncircular curvature.

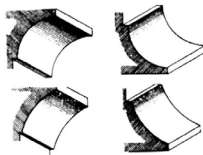

**cavetto types**



**Chancel arch**

**chancel arch =**

An arch which, in many churches, marks the separation of the chancel or sanctuary from the nave or body of the church.

**chapel =**

A small area within a church, containing an altar and intended for private prayers.

A room designated for religious purposes within a school.



**chapel**

**chevron =**

A molding showing a zig-zag sequence of these ornaments in Romanesque architecture.



**chevron**



**choir**

**choir =**

That part of the church, between the sanctuary and the nave, usually occupied by a group of singers.

**chord =**

The straight line between two points on a curve.  
The main member of a truss.

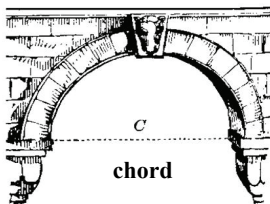

**chord**

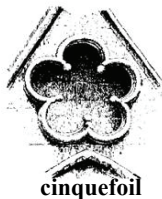

**cinquefoil**

**cinquefoil =**

A five-lobed pattern divided by cusps; see **arch-foil** and **cinquefoil**

**circular arch =**

An arch whose intrados takes the form of a segment of a circle.

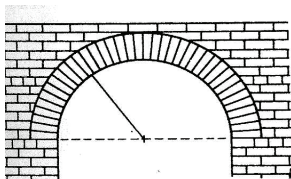

**Circular arch**

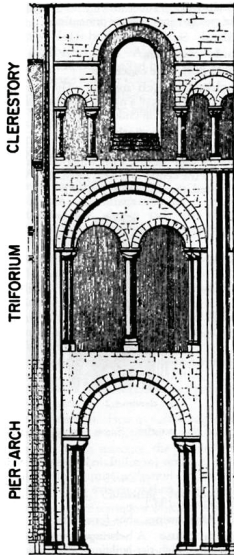

clerestory

**clerestory** =

An upper zone of wall pierced with windows that admit light to the center of a lofty room.

**triforium** =

A shallow passage above the arches of the nave below the clerestory.

**pier arch** =

An arch resting on piers, esp. one along a nave arcade, below the triforium.

**column** =

A cylindrical support consisting of a base (except in Greek Doric), shaft and capital; either monolithic or built up of drums the full diameter of the shaft to support a load.

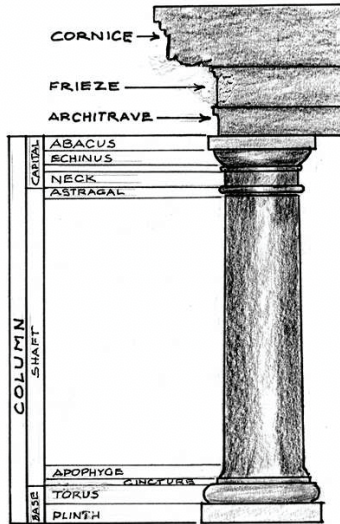

column order

**congé =**

A quarter-round concave molding, tangent to a vertical surface and succeeded by a fillet parallel to that surface.

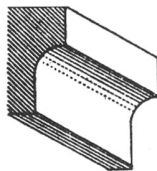

**congé**



**corbiestep**

**corbiestep, catstep, crow-step =**

The stepped edge of a gable, masking a pitched roof, 14<sup>th</sup> to 17<sup>th</sup> centuries.

**cornice =**

Any molded projection that crowns the part to which it is affixed.

The uppermost division of an entablature.

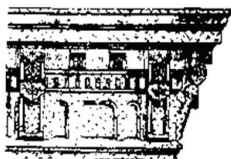

**cornice**

**corona =**



**corona**

The overhanging vertical member of a cornice, supported by the bed molding and crowned by the cymatium with a drip to divert the water away from the building.

**crenelated, crenel =**

A notched ornament intended to represent a battlement.

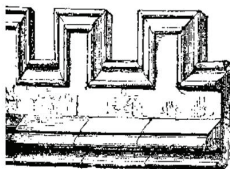

**crenelated**



**crocket**

**crocket =**

In Gothic architecture and derivatives, an upward-orientated ornament, vegetable in form, regularly spaced along features such as spires, pinnacles, and gables.

**crossettes =**

A small projecting part of a voussoir (arch stone), which hangs upon an adjacent stone.

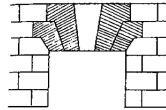

**crossettes**

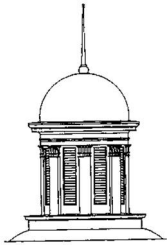

**cupola**

**cupola =**

A dome structure, often set on a circular or polygonal base on a roof or set of pillars, glazed to provide light or louvered to provide ventilation in that space.

**cusps =**

The intersection of two arcs in a tracery. The figure formed by the intersection of tracery arcs.



**cusps**



**cyma  
recta**



**cyma  
reversa**

**cyma, cima =**

A molding having a profile of double curvature, or an ogree profile.

**dais =**

A raised platform reserved for the seating of speakers or dignitaries.

**dais****date stone****date stone =**

A stone, imbedded in the walls, carved with the date of completion of the structure.

**decastyle =**

A structure having a portico of ten columns, or rows of ten columns.

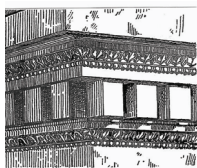
**decastyle****Ionic dentils****dentil =**

One of a band of small square, toothlike blocks forming part of the characteristic ornamentation of the Ionic, Corinthian and Composite orders, and sometimes the Doric.

**discharging arch =**

An arch, usually segmental and often a blind arch, built above the lintel of a door or window to discharge the weight of the wall above the lintel to each side.

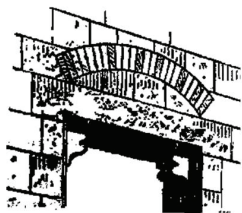
**discharging arch**

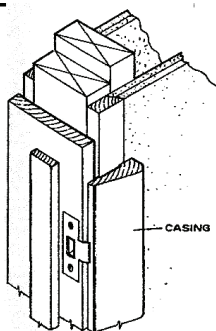
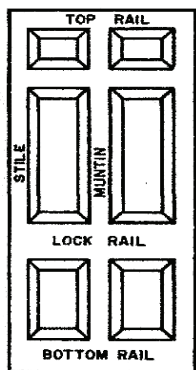

door nomenclature

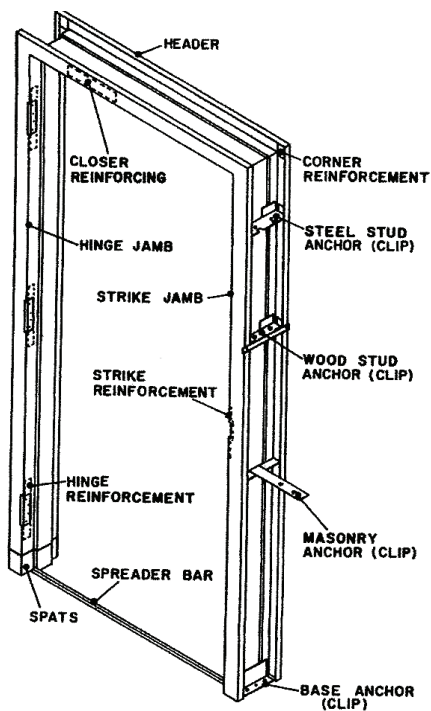



**echinus and astragal**

**echinus and astragal =**  
And ornament similar to egg and dart with a bead and a reel below it.



**Elliptical arch =**  
An arch having the shape of half an ellipse in its construction.

**Elliptical arch**



**encarpus**

**encarpus =**  
A sculpture festoon of fruit and flowers.

**engaged column =**  
**attached column =**  
A column partially built into a wall; not freestanding.

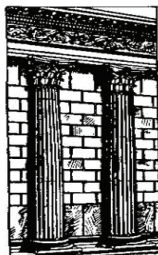

**engaged column**

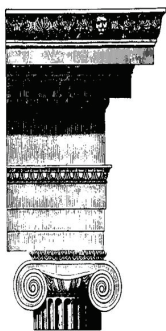

**entablature**

**entablature =**  
In Classical architecture, an elaborate horizontal band and molding supported by columns; horizontally divided into three basic elements: architrave (the lowest member), frieze the (middle member), and cornice (the uppermost member).

**entasis =**

The intentional slight curving of the vertical profile of a tapered column used to overcome the optical illusion of concavity that characterizes straight sided columns.

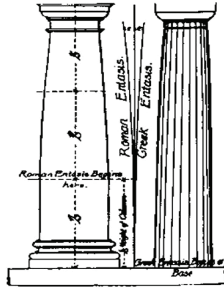

**entasis**



**épi**

**épi =**

The spire-shaped termination of a projecting point or angle of a roof.

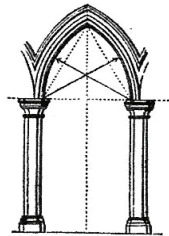

**equilateral arch**

**equilateral arch =**

A two-centered arch in which the chords of the curves just equal the span of the arch.

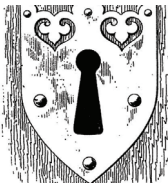

**escutcheon**

**escutcheon =**

A protective plate surrounding the keyhole of a door, a light switch, etc. also called **scutcheon**.

**exedra =**

A large niche or recess, usually with a bench or seats in a church.

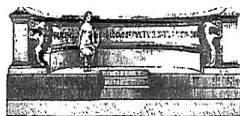

**exedra**



**extrados =**

The exterior curve or boundary of the visible face of the arch.

**Federal style =**

An architectural style in the post Colonial era in America, from about 1780 to 1820.



**Federal style**



**finial**

**finial =**

An ornament which terminates the point of a spire, pinnacle etc. Also called **acroterion**, crop, knob pineapple and pommel.

**fireback =**

The back wall of the fireplace of the fireplace of heat-resistant masonry of cast or wrought metal, not only decorative but radiates heat in the room.



**fireback**



**firemark**

**firemark =**

In colonial America, a plaque, usually cast in lead, affixed to the façade of a house, indicating that the owner had contributed money to the local fire department.

**flat arch =**

An arch whose soffit (i.e. lower face) is horizontal. Also called a Dutch arch or French arch or jack arch.



**Flat arch**

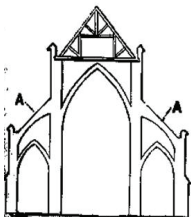

**A. = flying buttress**

**flying buttress =**

A feature in Gothic construction, in which the lateral thrust of a roof is taken by a projecting column of masonry, sloping and carried on an arch and a solid pier buttress.

**French door =**

A door having a top rail, bottom rail and stiles, which has glass panes throughout its entire length; often used as pairs.

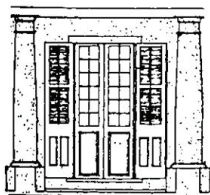

**French door**



**gargoyle**

**gargoyle =**

A waterspout projecting from the roof gutter of a building, often carved grotesquely.

**Georgian style =**

Known for its symmetrical features. Prevailing style from 1714 to 1830.



**Georgian architectural style.**

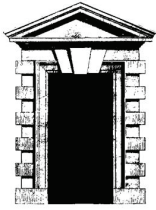

**Gibbs surround**

**Gibbs surround =**

The framing of a door or window by a head of a triple keystone and by jambs bordered by protruding rectangular blocks of stone.

**Gothic architecture =**

The architectural style of the High Middle Ages in Western Europe, which emerged from Romanesque and Byzantine forms in France during the later 12<sup>th</sup> century. Its great works are cathedrals, characterized by the pointed arch, rib vault, the development of the exterior **flying buttress**. Gothic architecture lasted until the 16<sup>th</sup> century, when it was succeeded by the classical forms of Renaissance.

The Gothic Revival of the 18<sup>th</sup> century flourished in Europe as well as in the United States. It is called the Late Gothic Revival or Victorian Gothic.

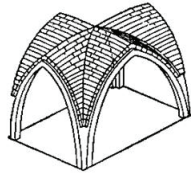

**Gothic construction**

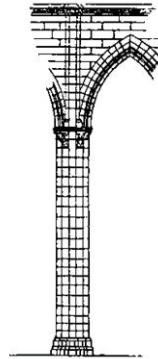

**Gothic pier**

**Greek Revival style =**

An architectural style based on the reuse of ancient Greek forms. Symmetrical in plan, this style was very popular in America from 1820 to 1850.



**Greek Revival**



**A = groins**

**groin =**

The ridge, edge, and or curved line formed by the intersection of the surfaces of two intersecting vaults.

**guilloche =**

An ornament formed by two or more bands twisted over each other in a continuous series, leaving circular openings, which are often filled with round ornaments.



**guilloche**



**guttae**

**guttae =**

In Classical architecture one of a number of pendant ornaments in a rectangular arrangement.

**hammer beam =**

One of a pair of short horizontal members attached to the foot of a principal rafter in place of a tie beam.

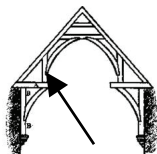

**hammer beam**

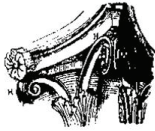

**helix**

**helix =**

Any spiral, particularly a small volute or twist under the abacus of the Corinthian capital or the volute of an Ionic capital.

**heptastyle =**

A portico having seven columns, at one or each end.



**heptastyle**



**herm**

**herm =**

A rectangular post, usually of stone and tapering downward, surmounted by a bust of Hermes or other divinity, or by a human head.

**hexastyle, exastyle =**

Having six columns, at one end or at each portico.



**hexastyle**



**hex barn**

**hex barn =**

A barn decorated with painted hex symbols called hexenfoos, found in Pennsylvania Dutch regions to protect the animals from harm cast by the “evil eye”.

**high relief, alto-relievo =**  
Sculpture relief work in which the figures project more than half of their thickness.



**High relief**

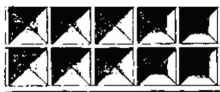

**hollow square molding**

**Hollow square molding =**  
A common Norman molding consisting of a series of indented pyramidal shapes having a square base.

**holy-water stone =**  
A stone basin for holding holy water, placed near the entrance of a church.

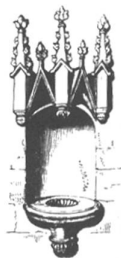

**holy-water stone**



**honeysuckle ornament**

**Honeysuckle ornament =**  
A common name for the **anthemion**, common in Greek decorative sculpture.



**hood**

**hood =**  
A cover placed above an opening or an object to shelter it.

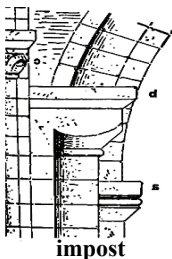

**impost =**

A traditional member, often tapered, placed above a column capital to receive the thrust of vaults or arches.

- A. impost of great arch.
- B. impost of apse vaulting.
- C. impost of wall arcades.

**inlay, intarsia, marquetry =**

A shaped piece of one material embedded in another as part of a surface ornamentation. Also such ornamentation as a whole. Also see: encaustic tile.



**inlay**

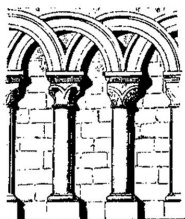

**interlacing arcade =**

Arches resting on alternate supports in one row, the arches overlapping in series where they cross. Also called intersecting arcades.

**interlacing arcade**

**inverted arch =**

An arch with its intrados below the springing line; used to distribute concentrated loads in foundations.

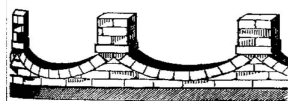

**inverted arch**

**isocephalic =**

In bas-relief, having the heads nearly on a horizontal line; esp. said heads of human figures in a frieze or band.



**isocephalic**

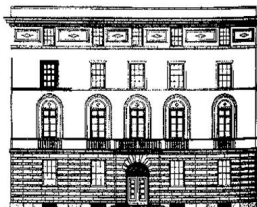

**Italian Renaissance**

**Italian Renaissance =**

An architectural style emulating the Renaissance palazzi of North Italy; popular from 1800s to about 1930. Characterized by facades that are symmetrical, two or three stories high with a different architectural treatment on different stories.

**joggle joint =**

A joint between two blocks of material (such as masonry) which fit one into to other by a joggle.



**joggle joint**



**labyrinth fret**

**labyrinth fret =** A fret with many involved turnings.

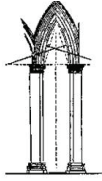

lancet arch

**lancet arch =**

A sharply pointed two-centered arch whose centers of curvature are much farther apart than the width of the arch; an **acute arch**.

**leaf and dart =**

In Greek architecture, a pattern of alternative conventionalized deltoid and lanceolate leaves, applied to **cyma reversa**.



Leaf and dart

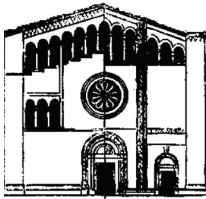

Lombard style

**Lombard style =**

Northern Italian pre-Romanesque architecture in the 7<sup>th</sup> and 8<sup>th</sup> cent., during the rule of Lombards, based on Early Christian and Roman forms.

**mansard roof =**

A roof having a double slope on all four sides, the lower slope being much steeper. (USA) same as gambrel roof.



mansard roof

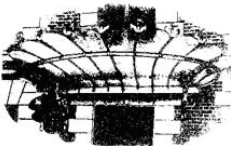

marquee

**marquee, marquise =**A permanent roof-like shelter over an entrance to a building.

**mascaron =**

The representation of a face, partly human head, more or less caricatured, used as an architectural ornament.

**mascaron****medallion molding****Medallion molding =**

A molding consisting of a series of medallions, example of Norman architecture.

**mission architecture =**

Church and monastic architecture of Spanish religious orders, especially in the Americas in the 18<sup>th</sup> century, displaying considerable regional variation as a result of influences of skills of local laborers and the availability of construction materials; relatively unadorned in some regions but considerably more elaborate in others, often with ornamentation imitative of the elaborate and lavish Baroque style. Mission architecture exhibits many of the following characteristics: thick massive walls of adobe brick, laid with lime mortar where available, commonly with wall buttresses to provide additional stability. The adobe walls are usually coated with lime-and-sand stucco to reduce the effect of erosion; tamped earth floors, decorated with square tile, arcaded walkways with arches built around the patios, a belfry, bell tower, or twin bell towers, thatched or tile roofs and grilles covering the windows facing the street.

**mission  
architecture**

**moldings =**

A member of construction, decoration or protection, generally divided in three categories, rectilinear, curved, and composite.

CROWNING MOLDINGS



cavetto



congé



cyma recta

SUPPORTING MOLDINGS



$\frac{1}{4}$  round



ovolo



echinus



cyma reversa



$\frac{1}{2}$  round



torus



thumb

SEPARATING MOLDINGS



$\frac{1}{2}$  hollow



fillet



bead



scotia

## moldings (continued)

### PRONE MOLDINGS



cavetto



scape



cyma recta



cyma reversa



ovolo

Moldings are also called **molds**. They are usually covering a joint or separating components.



mosaic

**mosaic** =

A pattern formed by inlaying small pieces of stone, tile, glass, or enamel into a cement mortar, or plaster matrix.

**mullion** =

A vertical member separating (and often supporting) windows, doors, or panels set in series.

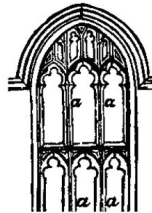

mullions

**mutule =**

A sloping flat block on the soffit of the Doric cornice, usually decorated with rows of six **guttae** each occurs over each triglyph and each metope of the frieze.



**mutule**

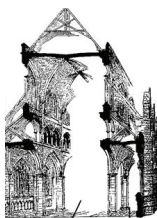

**nave**

**nave =**

The middle aisle of a church. By extension, both middle and side aisles of a church from the entrance to the crossing or chancel. That part of the church intended primarily for the laity.

**nebule, nebuly molding =**  
A characteristic Norman molding with an undulating lower edge.



**nebule molding**



**Neoclassicism**

**Neoclassicism =**

The reinterpretation of the principles of Classical architecture in the late 18<sup>th</sup> and 19<sup>th</sup> century and beyond. This term often includes the Federal style.

**niche =**

A recess in a wall, usually to contain sculpture or an urn; often semicircular in plan surmounted by a half dome.



**niche**

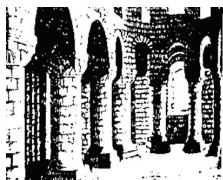

**Norman architecture**

**Norman architecture =**  
The Romanesque architecture of England from the Norman Conquest until the rise of the Gothic around 1180.

**north aisle =**

The aisle on the left side of a church as one faces the altar; so called because most medieval churches invariably had their sanctuaries at the east end and the main doors at the west end.

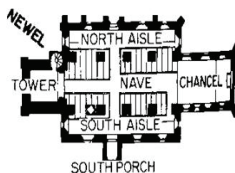

**north aisle**



**obelisk**

**obelisk =**

A monumental four-sided stone shaft, usually monolithic and tapering to a pyramidal tip. In Egyptian art, such a shaft is covered with hieroglyphs; originally erected as cult symbol to the sun god.

**obtuse angle arch =**

A type of pointed arch, formed by arcs of circles, which intersect at the apex.

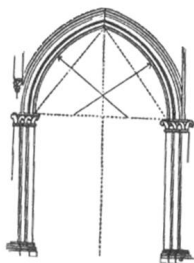

**obtuse arch**

**octagon house =**

An eight-sided house, usually two to four stories high, built primarily in the last half of the 19<sup>th</sup> century.



**octagon house**

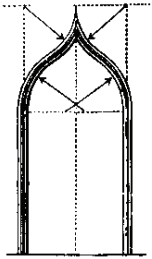

**ogee arch**

**ogee arch =**

A pointed arch composed of reversed curves, the lower concave and the upper convex.

**Palladian window =**

A large window divided in three parts: A central sash that is arched at the top and two sashes on each side with flat lintels.

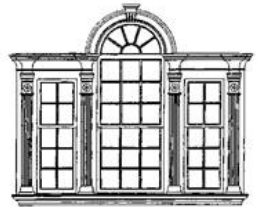

**Palladian window**



**palmette**

**palmette =**

An ornament derived from a palm leaf.

**paterae =**

A roundel often decorated with leaves or petals used as decorative element. (Rosette)

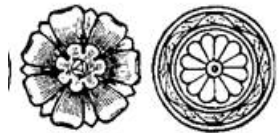

**paterae**



**pedestal**

**pedestal =**

A support for a column, statue, urn, etc., consisting in classical architecture of a base, dado, or die and a cornice, surbase, or cap; in modern design often a plain block.

**pediment =**

In classical architecture, a triangular gable usually having a horizontal cornice, with raked cornices on each side, surmounting or crowning a portico or another division of a façade.

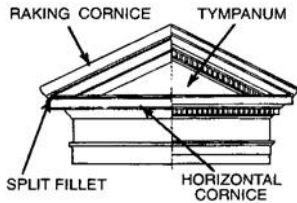

**pediment**



**pellet molding**

**pellet molding =**

A molding decorated with a series of small, flat disks or hemispherical projections.

**pendant =**

A suspended feature or hanging ornament used in the Gothic architecture.

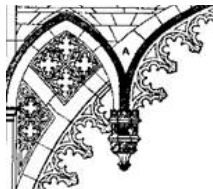

**pendant**

**perpend wall,  
perpeyn wall =**

A wall built of perpendis or of ashlar stones, all of which reach from one side to the other.

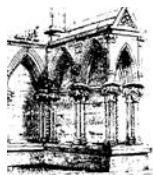

**perpend wall**



**perron**

**perron =**

An outdoor flight of steps, usually symmetrical, leading to a terrace of a large building.

**pinnacle =**

An apex.

A largely ornamental body, or shaft terminated by a pyramid or spire.

A turret, or component elevated above the main building.

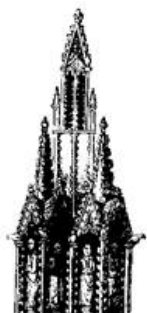

**pinnacle**



**plantation house**

**plantation house =**

The principal house of a plantation in the antebellum American south, typically having many characteristics: two stories, a projecting portico with

Classic columns and a recessed central bay, thick walls at ground level, and a raised basement in areas of high water table, which served as the location for service facilities, pantries, wine cellar and servants' room.

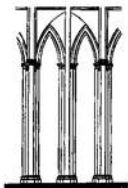

**pointed arch**

**pointed arch =**

Any arch with a point at its apex, characteristic of, but not confined to, Gothic architecture.

**porte cochère =**

A covered carriage or automobile entryway leading to a courtyard.



**porte cochère**



**postern**

**postern =**

A minor, often inconspicuous, entry.

A small door near a large one.

Any small door or gate, esp. one far from the main gate in a fortified place.

**pulpit =**

An elevated enclosed stand in a church in which the preacher stands.



**pulpit**



**Queen Ann arch**

**Queen Anne arch =**

An arch over the triple opening of the so-called Venetian or Palladian window, flat

over the narrow side lights, round over the larger central opening.

**raking cornice =**

A cornice following the slope of a gable, pediment, or roof.

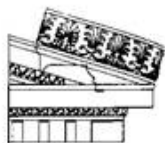

**raking cornice**

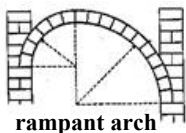

**rampant arch**

**rampant arch,  
raking arch =**

An arch in which the impost on one side is higher than on the other.

**reeding =**

An ornament of adjacent, parallel, protruding, half-round moldings (reeds); the reverse of fluting. Also see **cabbling**.



**reeding**



**refectory**

**refectory =**

A hall in a convent, monastery, or public secular institution where meals are served.

**reredos =**

An ornamental screen or ornamental wall at the back of an altar.



**reredos**



**respond**

**respond =**

A support, usually a corbel or pilaster, affixed to a wall to receive one end of an arch, a groin, or a vault rib.

**reticulated molding =**

A molding decorated with filets interlaced to form a network or mesh-like appearance



**reticulated molding**



**rib**

**rib =**

A curved structural member supporting any curved shape or panel. In a vaulted roof, the moldings which separate the various roof panels. A raised ridge to provide stiffness.

**rinceau =**

In Classical architecture and derivative, an ornamental band of undulant and recurring plant motifs.



**rinceau**



**Rococo**

**Rococo =**

A style of architecture and decoration, primarily French, which represents the final phase of the Baroque; characterized by profuse, often semiab-

stract ornamentation and lightness of color and weight.

**roll billet molding =**

A common Norman molding consisting of a series of billets, which are cylindrical in cross section, usually staggered in alternate rows.



**roll billet  
molding**

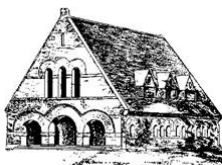

**Romanesque  
Richardsonian**

**Romanesque style =**

An architectural style emerging in Europe in the 11<sup>th</sup> century and lasting until the advent of Gothic architecture; based on Roman and Byzantine elements; found especially in churches, castles and public buildings. It is characterized by round arches and by massive articulated wall, barrel, groined and ribbed vaults; semicircular arches. It served as the basis of the Richardson Romanesque style practiced by Henry Hobson Richardson (1838 – 1886) and his followers making use of architectural elements of the Romanesque style.

**rose window =**

A large, circular medieval window containing tracery disposed in a radial manner.

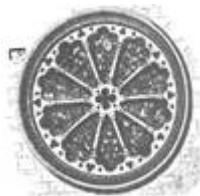

**rose window**

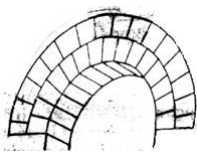

**rowlock arch**

**rowlock arch =**

An arch wherein the bricks or small voussoirs are arranged in concentric rings.

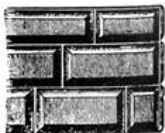

**rustic work**

**rustic work** =

Roughly faced stonework; the separate blocks are marked by deep **chamfers**.

**sacristy** =

A room in a church, near the chancel, where the robes and altar vessels are stored, where the clergy vest themselves for services and where some business of the church may be done.



**sacristy**



**sarcophagus**

**sarcophagus** =

An elaborate coffin for important personage, of terracotta, stone, or metal decorated and large enough for only one body. If larger = tomb.

**scalloped molding** =

One of continuous series of curves resembling segments of a circle, used mainly as a decorative element.

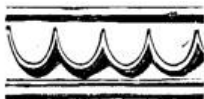

**scalloped molding**

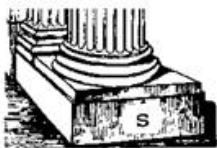

**scamillus**

**scamillus** =

A plain block placed under the plinth of a column, forming a double plinth.

**scotia =**

A deep concave molding, esp. one at the base of a column in Classical architecture.



**scotia**



**scroll**

**scroll =**

An ornament of a spirally wound band, either as a running ornament or as a terminal like the volutes.

**shank =**

One of the plain spaces between the channels of a triglyph in a Doric frieze.

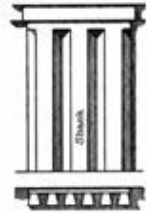

**shank**

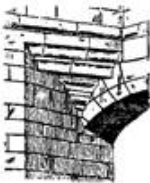

**skew arch**

**skew arch =**

An arch whose vertical sides are not at an angle of 90 degrees to its face.

**skewback =**

The sloping surface of an abutment which receives the thrust of an arch.

The stone or course of stones, or steel plate, providing such a sloping surface.

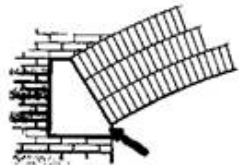

**skewback**



**smalto**

**smalto** =

Colored glass or other pieces of vitreous materials, esp. in minute regular squares, used in mosaic work.

**spandrel** =

An area, roughly triangular in shape, included between the extradoses of two adjoining arches and a line approximately connecting their crowns (or a space approximately equal to half in case of a single arch); often ornamented with tracery.



**spandrel**

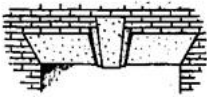

**splayed lintel**

**splayed lintel** =

An horizontal lintel above a window, each end of which slants toward a center line through the window; often has a keystone at its center.

**spur** =

A decorative appendage of the base of a round column resting on a square or polygonal plinth.

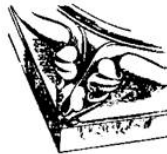

**spur**



**stepped arch**

**stepped arch** =

An arch in which the voussoirs are cut horizontally and/or vertically so they fit in with the masonry courses above and below, forming steps.

**stilted arch =**

An arch whose curve begins above the impost line.

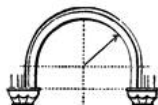

**stilted arch**



**swan's neck  
pediment**

**swan's neck pediment =**

A broken pediment having a sloping double S-shaped decorative element on each side; said to be suggesting of the neck of a pair of swans.

**tabernacle =**

A decorative niche often topped with a canopy and housing a statue. Also a church for a large Protestant congregation.



**tabernacle**

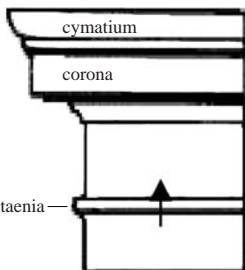

taenia —

**taenia**

**taenia, tenia =**

A narrow raised band or fillet, particularly the topmost member of the Doric architrave.

**telamon (pl. telamones) =**

A sculptured male human figure used in place of a column to support an entablature, also called **atlas**.



**telamon**



**tongue-and-dart  
molding**

**tongue-and-dart  
molding =**

A decorative molding consisting of tongue-like ornament alternating with dartlike ornament.

**torus =**

A bold projecting molding, convex in shape, generally forming the lowest member of a base over the plinth.

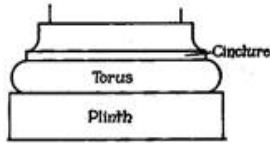

**torus**

**tracery =**

The curvilinear openwork shapes of stone or wood creating a pattern within the upper part of a Gothic window, or an opening, in the form of mullions, which are usually treated to be ornamental.

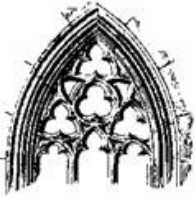

**tracery**

**transitional style =**

An architectural mode in a period between two different architectural styles, as for example, between late Georgian and early Federal style. Such a transition may occur at different times in different parts of the country.



**transitional  
style**

### **triglyph =**

The characteristic ornament of the Doric frieze, consisting of slightly raised blocks of three vertical bands separated by V-shaped grooves.

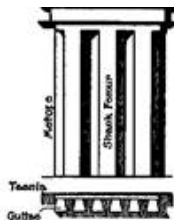

**triglyph**



**Tudor architecture**

### **Tudor architecture =**

The final development of Perpendicular style architecture during the reigns of Henry VII and Henry VIII, preceding the Elizabethan architecture. It is characterized by Tudor arches, diaperwork, strapwork,

labels and label stops over windows with mullions, and ornate brick chimneys.

### **Tudor Revival,**

### **Tudor style =**

A term descriptive of a picturesque mode of domestic architecture prevalent from about 1880 to 1940 and beyond, emulating its



**Tudor Revival**

Tudor architecture prototype. Homes in this style, usually asymmetrical in plan, often were clad in brick or stucco in combination with wood, and commonly had false half-timbering surface ornamentation consisting of strapwork, steeply pitched gables, a shingled roof, elaborate chimneys and leaded windows.



**tympanum**

**tympanum =**

The triangular or segmental space enclosed between the horizontal cornice of a pediment and the underside of the raking or curved cornice.

**vinette, vignette =**

An ornament of running vine scrolls with grapes clusters and leaf-work.



**vinette**

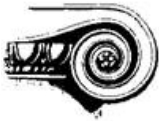

**volute**

**volute =**

A spiral scroll, as on Ionic, Corinthian, Composite capitals, or on consoles, etc.

**vousoir =**

A wedge-shape masonry unit in an arch or vault whose converging sides are cut as radii of one of the centers of the arch or vault.

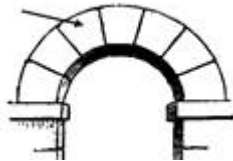

**vousoir**



**water leaf**

**water leaf =**

An ornamentation of lotus leaf or an ivy

motif, sometimes divided symmetrically by a prominent rib, also called lesbian leaf. Late 12<sup>th</sup> century capital with a large leaf at each angle, broad, smooth, curving up toward the abacus corner and then curling inward.

## window nomenclature

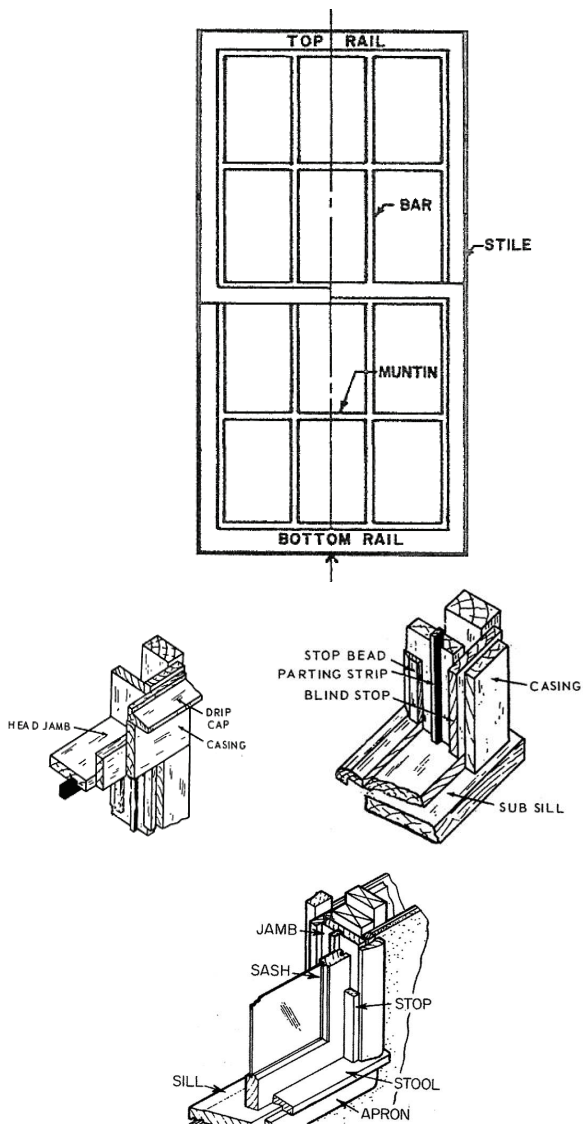

**window surround =**

A decorative element or structure on the exterior wall surface around the window.



**window surround**

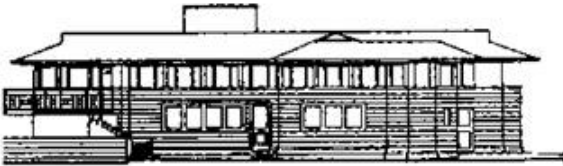

**Wrightian: Glasner House, Glencoe, Ill.  
Designed by Frank Lloyd Wright**

**Wrightian =**

An imprecise term suggestive of the work of Frank Lloyd Wright (1867 – 1959) and some of his followers. Wright cannot be characterized by a single architectural style; for example, some of his early buildings, closely associated with the **Prairie School**, differ markedly from his later design. Also see **Organic architecture and Prairie style**.

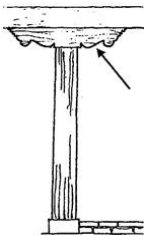

**zapata**

**zapata =**

In Spanish Colonial architecture of the Americas, a horizontal piece of wood, atop a post, that provides greater bearing area to support the load imposed on the post from above; usually carved similar to a bolster.

**END OF CHAPTER VI.**



©Copyright 2026 TCC Materials® All rights reserved.

No part of this book may be reproduced or transmitted in any form, by any means, electronic or mechanical, including photocopying, recording, or by any information storage and retrieval system, without permission in writing from publisher.

Any unauthorized use of this dictionary will be pursued to the full extent of federal and state law, including the imposition of civil and criminal penalties

Published By:



2025 Centre Pointe Blvd, Mendota Heights, MN 55120

Phone: 651.686.9116 • Web: [www.tccmaterials.com](http://www.tccmaterials.com)